

FAAST FLEX Product Guide



FLX-010

FLX-020

March 2022
Doc. No. A05-7020-000
DocManager No.36639_01

Intellectual Property and Copyright

THIS DOCUMENT CONTAINS PROPRIETARY INFORMATION OF HONEYWELL INTERNATIONAL INC. AND/OR ITS SUBSIDIARIES (“HONEYWELL”), AND CONTAINS HONEYWELL TRADE SECRETS. NEITHER THIS DOCUMENT NOR THE INFORMATION CONTAINED HEREIN SHALL BE REPRODUCED, USED, DISTRIBUTED OR DISCLOSED TO OTHERS WITHOUT THE WRITTEN CONSENT OF HONEYWELL. NOTHING CONTAINED HEREIN SHALL BE CONSTRUED AS CONFERRING BY IMPLICATION, ESTOPPEL, OR OTHERWISE ANY LICENSE TO ANY PATENT, TRADEMARK, COPYRIGHT OR OTHER INTELLECTUAL PROPERTY RIGHT OF HONEYWELL OR ANY THIRD PARTY. © Honeywell 2021

Disclaimer

The contents of this document is provided on an “as is” basis. No representation or warranty (either express or implied) is made as to the completeness, accuracy or reliability of the contents of this document. The manufacturer reserves the right to change designs or specifications without obligation and without further notice. Except as otherwise provided, all warranties, express or implied, including without limitation any implied warranties of merchantability and fitness for a particular purpose are expressly excluded.

General Warning

This product must only be installed, configured and used strictly in accordance with the General Terms and Conditions, User Manual and product documents available from Xtralis. All proper health and safety precautions must be taken during the installation, commissioning and maintenance of the product. The system should not be connected to a power source until all the components have been installed. Proper safety precautions must be taken during tests and maintenance of the products when these are still connected to the power source. Failure to do so or tampering with the electronics inside the products can result in an electric shock causing injury or death and may cause equipment damage. Xtralis is not responsible and cannot be held accountable for any liability that may arise due to improper use of the equipment and/or failure to take proper precautions. Only persons trained through an Xtralis accredited training course can install, test and maintain the system.

Liability

You agree to install, configure and use the products strictly in accordance with the User Manual and product documents available from Xtralis.

Xtralis is not liable to you or any other person for incidental, indirect, or consequential loss, expense or damages of any kind including without limitation, loss of business, loss of profits or loss of data arising out of your use of the products. Without limiting this general disclaimer the following specific warnings and disclaimers also apply:

Fitness for Purpose

You agree that you have been provided with a reasonable opportunity to appraise the products and have made your own independent assessment of the fitness or suitability of the products for your purpose. You acknowledge that you have not relied on any oral or written information, representation or advice given by or on behalf of Xtralis or its representatives.

Total Liability

To the fullest extent permitted by law that any limitation or exclusion cannot apply, the total liability of Xtralis in relation to the products is limited to:

- i. in the case of services, the cost of having the services supplied again; or
- ii. in the case of goods, the lowest cost of replacing the goods, acquiring equivalent goods or having the goods repaired.

Indemnification

You agree to fully indemnify and hold Xtralis harmless for any claim, cost, demand or damage (including legal costs on a full indemnity basis) incurred or which may be incurred arising from your use of the products.

Miscellaneous



If any provision outlined above is found to be invalid or unenforceable by a court of law, such invalidity or unenforceability will not affect the remainder which will continue in full force and effect. All rights not expressly granted are reserved.

Document Conventions

The following typographic conventions are used in this document:

Convention	Description
Bold	Used to denote: emphasis. Used for names of menus, menu options, toolbar buttons
<i>Italics</i>	Used to denote: references to other parts of this document or other documents. Used for the result of an action.

The following icons are used in this document:

Convention	Description
	Caution: This icon is used to indicate that there is a danger to equipment. The danger could be loss of data, physical damage, or permanent corruption of configuration details.
	Warning: This icon is used to indicate that there is a danger of electric shock. This may lead to death or permanent injury.
	Warning: This icon is used to indicate that there is a danger of inhaling dangerous substances. This may lead to death or permanent injury.

Contact Us

UK and Europe	+44 1442 242 330
The Americas	+1 800 229 4434
Middle East	+962 6 588 5622
Asia	+86 10 56697101
Australia and New Zealand	+61 3 9936 7000
www.xtralis.com	

Codes and Standards Information for Air Sampling Smoke Detection

We strongly recommend that this document is read in conjunction with the appropriate local codes and standards for smoke detection and electrical connections. This document contains generic product information and some sections may not comply with all local codes and standards. In these cases, the local codes and standards must take precedence. The information below was correct at time of printing but may now be out of date, check with your local codes, standards and listings for the current restrictions.

FCC Compliance Statement

This equipment has been tested and found to comply with the limits for a Class B digital device, pursuant to part 15 of the FCC Rules. These limits are designed to provide reasonable protection against harmful interference in a residential installation. This equipment generates, uses and can radiate radio frequency energy and, if not installed and used in accordance with the instruction, may cause harmful interference to radio communications. However, there is no guarantee that interference will not occur in a particular installation. If this equipment does cause harmful interference to radio or television reception, the user is encouraged to try to correct the interference by one or more of the following measures; re-orientate or relocate the receiving antenna, increase the separation between the equipment and receiver, connect the equipment to a power outlet which is on a different power circuit to the receiver or consult the dealer or an experienced radio/television technician for help.

Regional Regulatory Requirements and Notices

European Installations

<p>Honeywell Products and Solutions Sàrl Zone d'activités La Piece 16 CH-1180 ROLLE Switzerland</p> <p>CE DoP: DOP-ASP038</p>
<p>EN 54-20: 2006 Aspirating smoke detectors for fire detection and fire alarm systems for buildings Classes: A, B and C</p>

Product Listings

- VdS
- EN 54-20, ISO 7240:20
- ActivFire

Honeywell Products & Solutions Sarl
Z.A. La Pièce 16
1180 ROLLE (SWITZERLAND)

Doc. No. A05-7020-000
DocManager No. 36639_01

Table of Contents

1	Introduction	3
1.1	Unit Description	3
1.2	Storage and Shipping	3
1.3	Ordering Information	4
2	Specifications	5
3	General Information	6
4	Major Components	7
5	Front Panel Indicators	8
6	Audible Alarms	9
7	Physical Installation	10
7.1	Orientation	10
7.2	Front Label	10
7.3	Instruction Sheet	11
7.4	Removing the Cover	12
7.5	Cable Access	12
7.6	Piping Considerations	13
7.7	Mounting the Unit	14
8	Wiring Installation	16
8.1	Wiring Considerations	16
8.2	GPI (General Purpose Input)	16
9	Relay Outputs	17
10	User Interface	19
11	Working Modes	20
11.1	INITIALIZATION Mode	20
11.2	PROTECTION Mode	20
11.3	SERVICE (or STANDBY) Mode	21
11.4	NORMAL Mode	21
11.5	WAIT Mode	21
11.6	DISABLED Mode	22
12	Changing the Passcode	23
13	Authenticating - Entering Passcode	25
14	Configuration	26
14.1	Configuration Modes	26
14.2	DIP Switch Configuration	27
14.3	Changing Configuration Mode	30
15	Test Mode	31
16	Normalize	33
17	Resetting Alarms and Faults	34
18	EEPROM Factory Reset	35
19	Passcode Recovery	36
20	Maintenance	37
20.1	Sensor Replacement	37
20.2	Aspirator Replacement	38
20.3	Filter Replacement	39
21	Event Logs	40

22 Piping Design Guidelines 45
23 Battery Removal for Recycling 59

1 Introduction

The FLEX Series is part of the Fire Alarm Aspiration Sensing Technology® (FAAST) family. FAAST is an advanced fire detection system for use where configurability, sensitivity and very early warning are a requirement. The system continuously draws air from the monitored environment through a series of sampling holes to monitor the environment for smoke particulate.

The FLEX has two channel capability with two high sensitivity smoke sensors in separate chambers (one sensor for each channel).

Note: Aspirating Smoke Detectors supplied and installed within the EU must conform to the EU Construction Products Regulation (CPR) 305/2011 and the related European Product Standard EN 54-20. FAAST has been tested and certified to ensure that it conforms to the necessary Standards, but strict adherence to this instruction guide is advised to ensure that the installation meets the requirements of the CPR.

This equipment and all associated pipe work must be installed in accordance with all relevant codes and regulations.

1.1 Unit Description

The FAAST FLEX is an aspirating smoke detector that provides early warning detection using a dedicated medium sensitivity smoke sensor. The FAAST FLEX is available as a one channel or two channel detector. Each sensing channel consists of an inlet, a metallic filter, a sensing element and a flow monitoring system. The product has a single aspirator and a single exhaust outlet. The FAAST FLEX is powered by an external 24 VDC power supply. Front panel LEDs indicate power, fault, and alarm status, and fault relays are activated in normal operation, and open in the event of a fault to notify monitoring systems. One General Purpose Input (GPI) is also provided.

Configuration of the device is typically via DIP switches on the circuit board. The circuit board also has a USB port that can be used by maintenance technicians to download event logs.

Components subject to periodic maintenance are designed to be easily reachable in any cabling situation. An in-line filter can be installed on the piping close to the inlet in order to improve protection to the sensing elements in particularly harsh (e.g. dusty) environments. The product is designed to protect an area up to 1600m² for 1 channel models and 2000 m² for two channel models. The product is designed to be compliant with EN54-20 Class A, B, and C sensitivity requirements.

1.2 Storage and Shipping

The FAAST FLEX detectors are shipped in specifically designed cartons. If the detectors must be stored, store the devices in the original shipping cartons. The product should be stored in an environmentally controlled, clean, dry, well ventilated area free from any corrosive agents. Do not store the devices for more than one year.

The detectors can be damaged by rough handling. During transportation, avoid violent vibration, heavy shock loads, and exposure to excessive heat or moisture.

1.3 Ordering Information

Ordering Code	Description
FLX-010	FAAST FLEX 1-pipe Stand-alone
FLX-020	FAAST FLEX 2-pipe Stand-alone
FLX-SP-01	FAAST FLEX Sensing Module
FLX-SP-02	FAAST FLEX Metal Filter (pack of 6)
FLX-SP-03-EN	FAAST FLEX Front Cover (EN)
FLX-SP-03-CH	FAAST FLEX Front Cover (CH)
FLX-SP-04	FAAST FLEX Aspirator
FLX-SP-05-EN	FAAST FLEX INTERNAL COVERS SET EN
FLX-SP-05-CH	FAAST FLEX INTERNAL COVERS SET CH

2 Specifications

Table 2-1: FAAST FLEX Detector Specifications

Specification	Value
Electrical Characteristics	
Voltage Range	24V Nominal
Supply Current (@24 VDC 25°C)	Single Channel Model: 200 mA (typical) 400 mA (max) @ 24V
	Dual Channel Model: 220 mA (typical) 450 mA (max) @ 24V
General Purpose Input (GPI)	Activation Time 2s (min)
Relay Contact Ratings	2.0 A @ 30 VDC, 0.5 A @ 30 VAC
Environmental Ratings	
Operating Conditions	Temperature: <ul style="list-style-type: none"> • Ambient: -40 °C to 55 °C (-40°F to 131°F) • Sampled Air: -40 °C to 55 °C (-40°F to 131°F) Humidity: <ul style="list-style-type: none"> • 10-93% RH, non-condensing
Flow Fault	± 20% of the reference flow
IP Rating	40
Mechanical	
Exterior Dimensions	204 mm x 280 mm x 80.5 mm
Wiring	0.5 mm ² to 2.5 mm ² maximum
Single Channel Model	Linear pipe length: 2 X 105m Branched pipe length: 4 X 68m
Maximum Number of Holes	Refer to section "22 Piping Design Guidelines" for more information.
Pipe Spec (EN54-20 Compliance)	EN 61386 (Crush 1, Impact 1, Temp 31)
Outside Pipe Diameter	27 mm (nom) or 25 mm (nom) with plug/adapter
Shipping Weight	1.7 kg (including sensors)

3 General Information

Figure 3-1 shows the information label on the FAAST FLEX. There is a QR code that can be scanned to access the online manual, and a barcode that can be scanned to access the model and serial number.

Power Requirements

The device requires an external 24 VDC power supply. In order to meet EN54-20 standard, the aspirating detector shall be supplied by a power supply complying with European Standard EN54-4. Operational Power Supply range is 18-30V. The device monitors the power supply and when supply voltage drops below 21V the device gives a LOW POWER alert (POWER LED shows steady RED). Moreover, the device has a brown-out circuit, which operates nominally at 17V. In this condition the device switches to POWER OUT OF RANGE state and activates fault relays. When the device is turned off by brown-out hardware circuit, the fault relays remains activated.

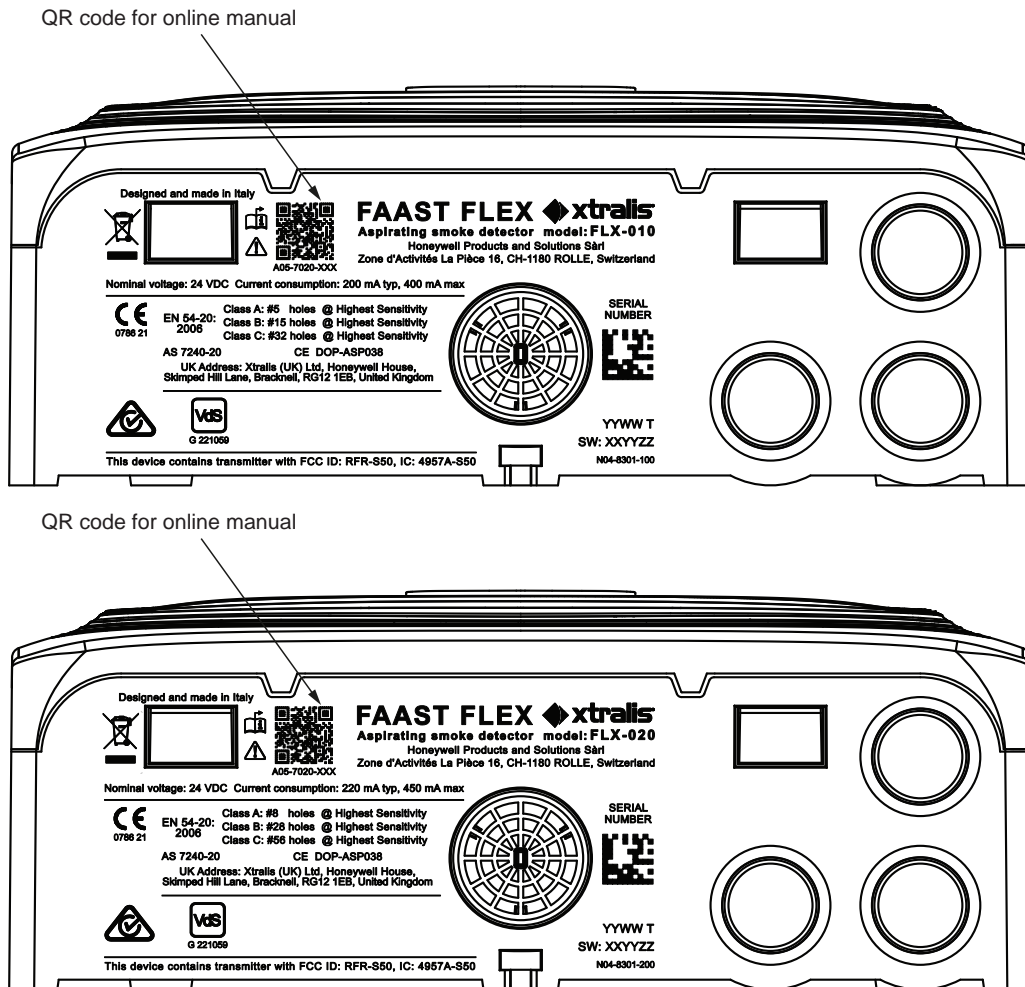

Figure 3-1: FAAST FLEX Product Information

4 Major Components

Figure 4-1 shows the major components of the FAAST FLEX. The FAAST FLEX is available in 1 Channel and 2 Channel models. For simplicity, the 2 Channel version is shown in illustrations in this manual unless there is an important difference between the two models.

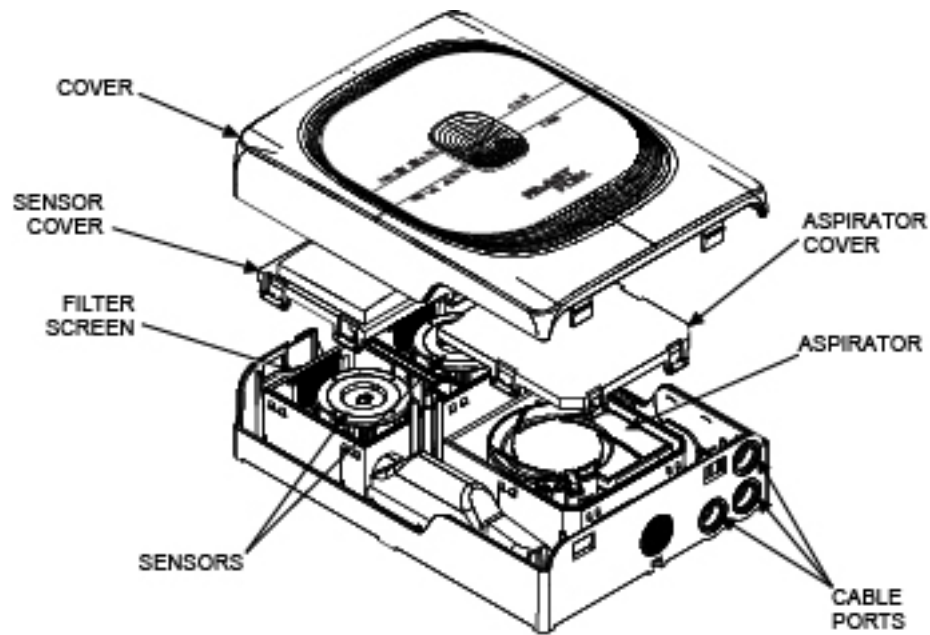

Figure 4-1: FAAST FLEX Major Components

5 Front Panel Indicators

The FAAST FLEX front panel has six indicator LEDs that communicate status information to the operator (see Figure 5-1).

Table 5-1: LED Indicators

LED	Indications	Meaning
CHANNEL 1 ALARM	Yellow, Steady	Delay timer activated on Channel 1/2
CHANNEL 2 ALARM	Red, Steady	Alarm condition on Channel 1/2
CHANNEL 1 ACTION	Yellow, Steady	Delay timer activated on Channel 1/2
CHANNEL 2 ACTION	Red, Steady	Action condition on Channel 1/2
POWER	Green, Steady	Power on, normal operation
	Green, Fast Blink	Bluetooth scanning in progress; or Disable mode
	Green, Slow Blink	Change configuration
	Yellow, Steady	Power on, system initializing
	Red, Steady	Protection mode - over voltage condition exists
	Red, Fast Blink	Service mode
FAULT	Green, on for 3 seconds	Operation successful
	Green, fast blink	Following initialization, indicates extended configuration is being loaded
	Yellow, Steady	One or more faults detected
	Yellow, Fast Blink	Waiting for user confirmation during configuration
	Yellow, Slow Blink	One or more alerts detected
	Red, on for 3 seconds	Operation result failed
	Red, Fast Blink	Normalize procedure in process

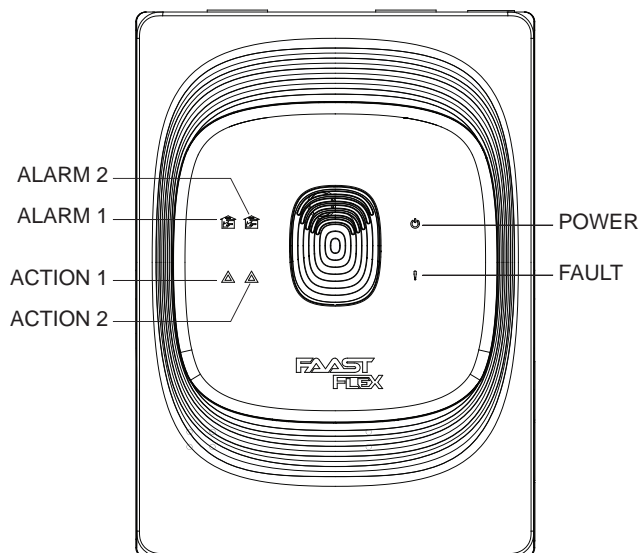

Figure 5-1: FAAST FLEX Indicator LEDs

6 Audible Alarms

The FAAST FLEX has a buzzer that provides the following audible feedback:

- Buzzer will sound whenever the user presses a button.
- Buzzer will sound for 0.5 seconds when the NORMALIZE procedure is completed (See section 16 Normalize).
- Buzzer will sound for 0.5 seconds when a data log file has been written to the USB drive (See section 15 Test Mode).
- Buzzer will sound for 0.5 seconds when the cover is opened or closed and there is a conflict between the DIP switch settings and the current device configuration (for example, if a DIP switch has been accidentally changed). See section 14 Configuration.

7 Physical Installation

7.1 Orientation

The FAAST FLEX can be mounted either in standard orientation or inverted (see Figure 7-1). The access and location of the inlet and outlet pipes is usually the determining factor in selecting the orientation.

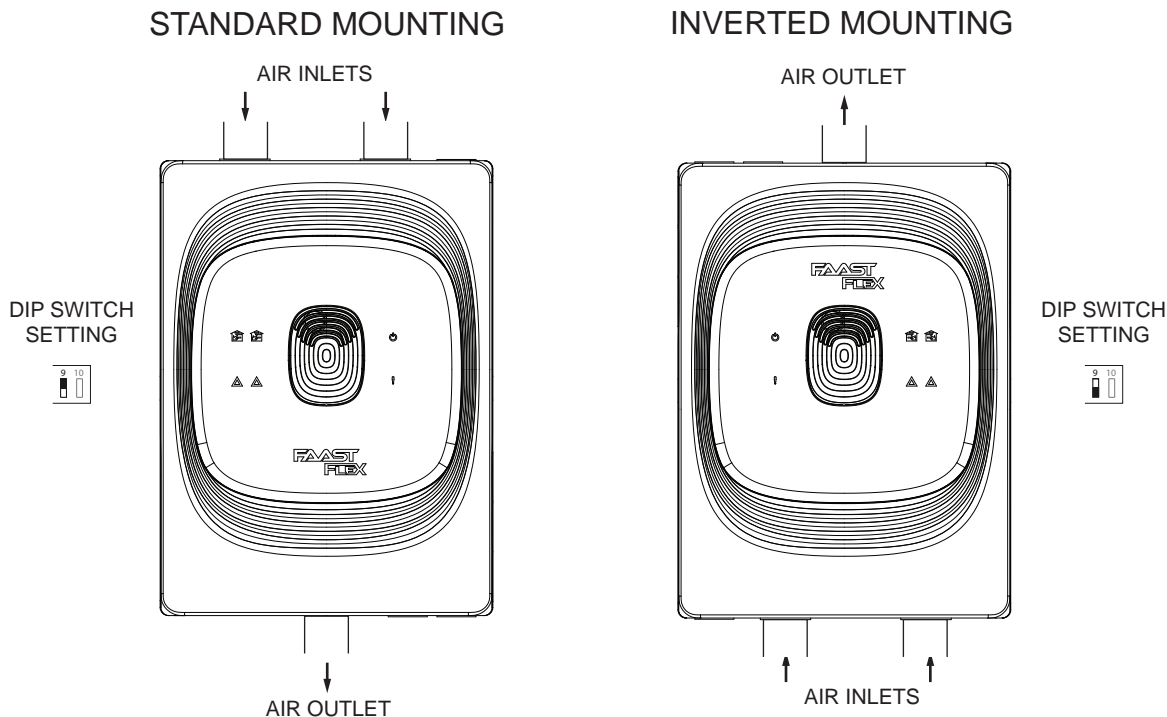

Figure 7-1: Mounting Orientation

7.2 Front Label

The device is shipped with the front panel labels installed for standard mounting. The labels are double-sided; one side is printed for standard mounting, and the reverse side is printed for inverted mounting (see Figure 7-2). The label should be installed to match the mounting orientation. To place the label, detach the 4 gray clips from inside the cover and snap the retainers off the device. Position the label as desired, then snap the retainer back in place.

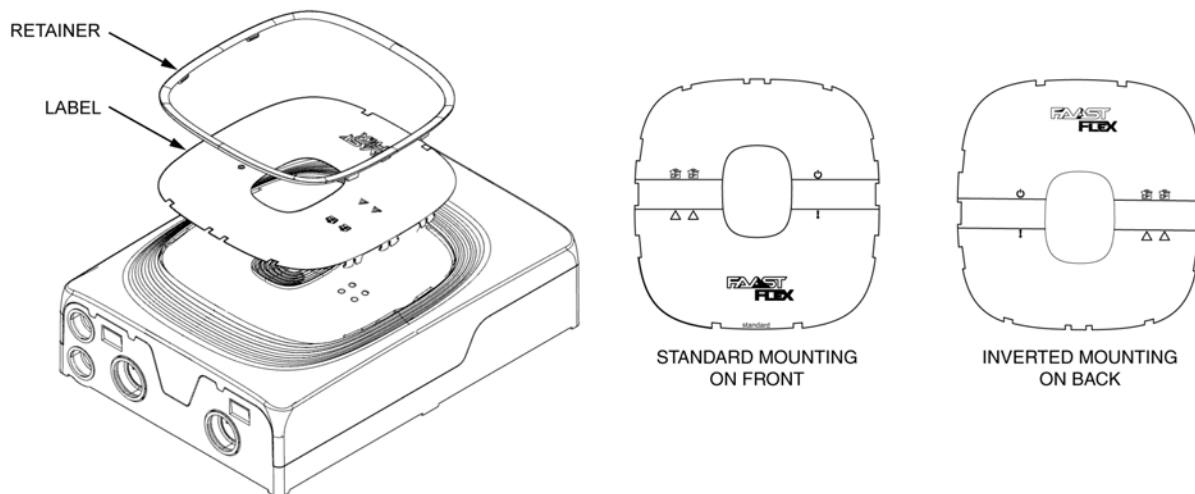

Figure 7-2: Front Label Installation

7.3 Instruction Sheet

Included with the FAAST FLEX is a graphical instruction sheet to assist installation.

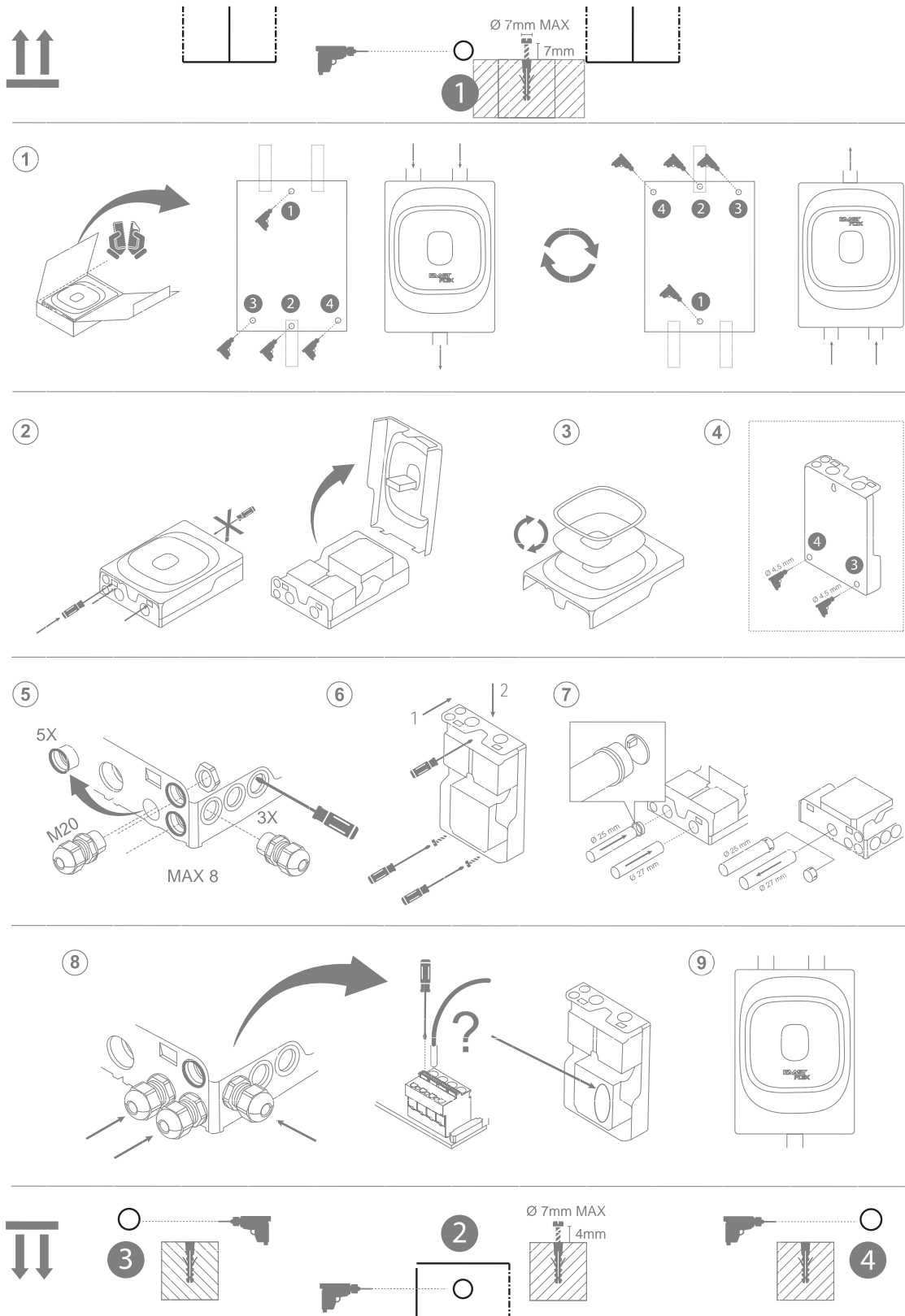

Figure 7-3: Graphical Installation Instructions

7.4 Removing the Cover

1. Using a small screwdriver or other suitable tool, press in the two **tabs on the inlet side of the FAAST FLEX** (see Figure 7-4).
2. Rotate the cover up as shown and remove it.

USE SCREWDRIVER TO PRESS IN TWO TABS

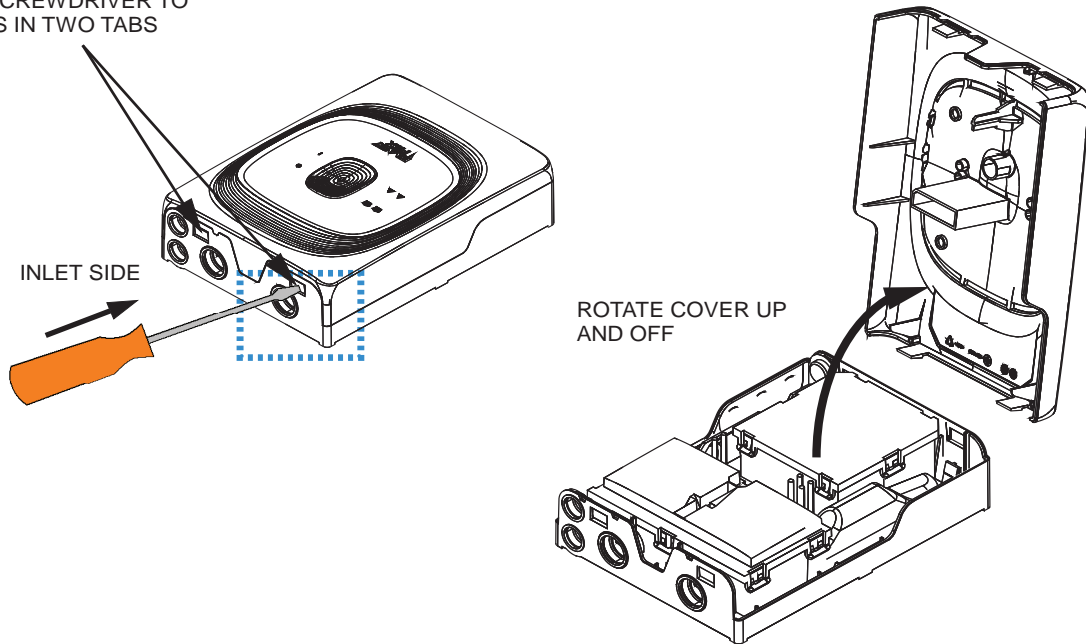

Figure 7-4: Removing the Cover

7.5 Cable Access

Determine the cable gland holes that will be used for your installation. The specific holes used will be different depending on the specifics of your installation. The top and bottom cable ports use a 20mm gland. For the side ports, you must use an appropriate punch tool (such as a screwdriver) to gently tap the covers out of the selected holes. Figure 7-5 shows the locations of the available cable ports.

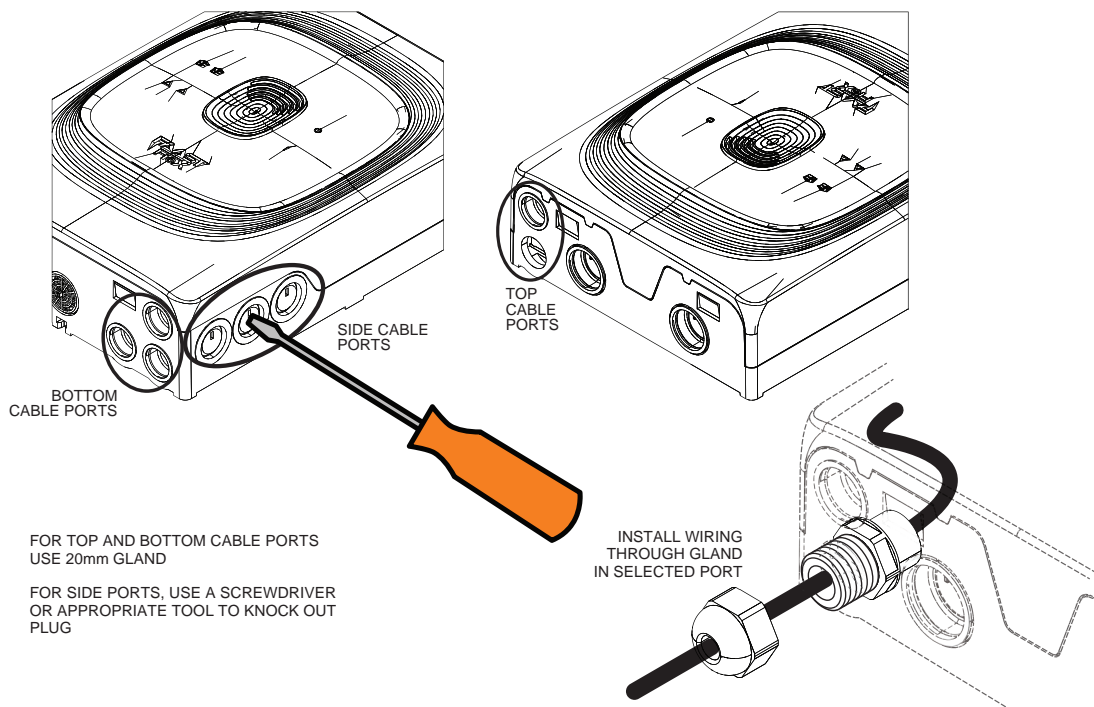

Figure 7-5: Cable Ports

7.6 Piping Considerations

1. Inlet ports that are not used should remain sealed.



Caution: DO NOT glue piping into the inlet and exhaust ports. Pipes that are glued in will be deemed out of warranty, since they cannot be tested.

2. To avoid contamination by dust, debris, insects, or spiders, It is recommended that inlet and exhaust ports remain plugged before use. Seal up inlet and exhaust ports if the device is turned off during maintenance periods.
3. Whenever the FAAST FLEX is installed outside the risk area, it is recommended that the exhaust air from the device be returned to the risk area. This will reduce flow faults caused by pressure differences (see Figure 7-6).

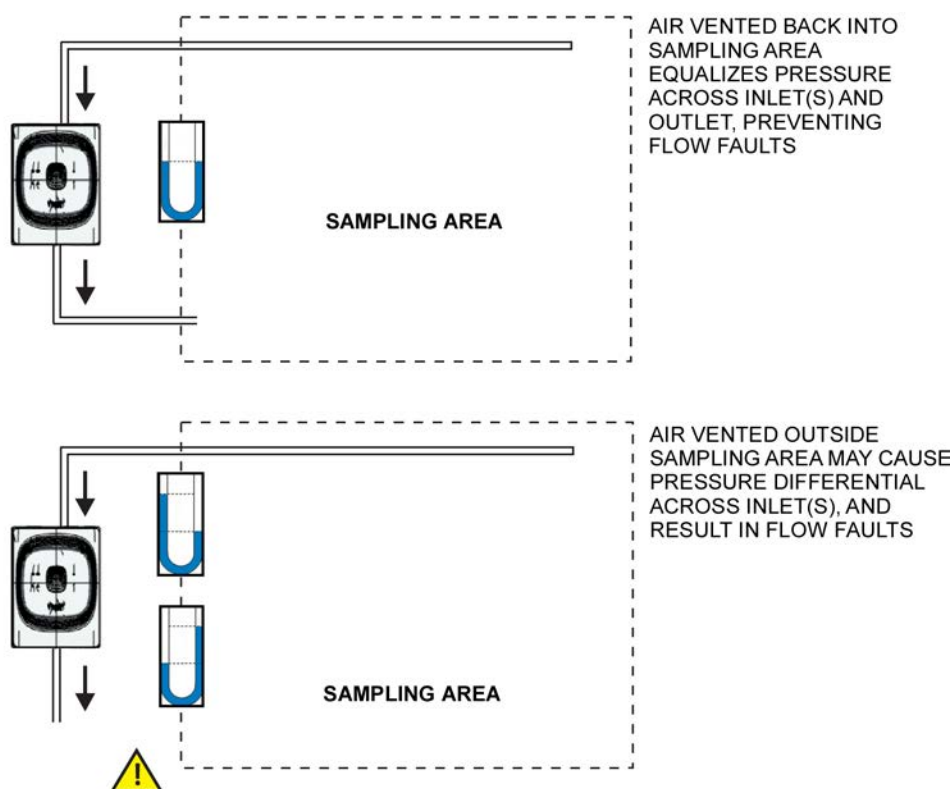

Figure 7-6: Piping Considerations

4. DO NOT USE GLUE OR ADHESIVE. The FAAST FLEX ports are designed to provide a complete seal without the use of any adhesives, glues, or other substances.
5. The FAAST FLEX is designed to accommodate either 27mm or 25mm pipe. If 25mm piping is used, an adapter is required. On the inlets, the pipe plugs can be used as an adapter by removing the center of the plug to open it up (see Figure 7-7). On outlet piping, the screen can be used as an adapter with 25mm piping (see Figure 7-8).

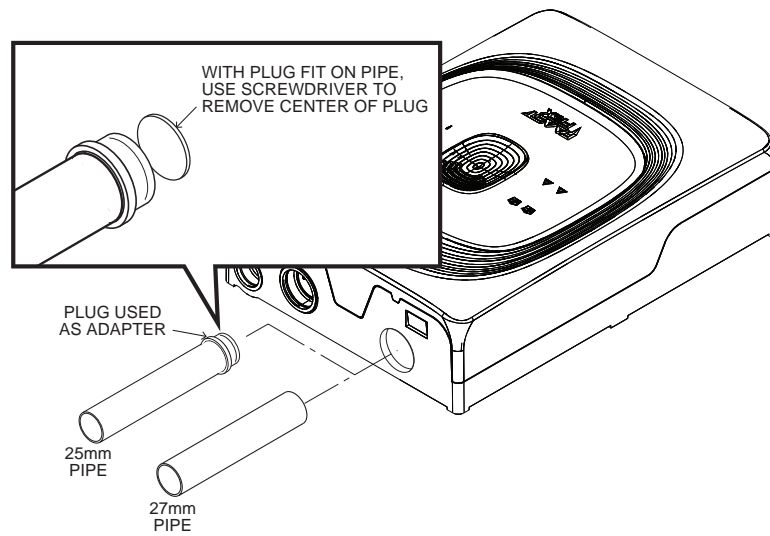

Figure 7-7: Inlet Piping Connections

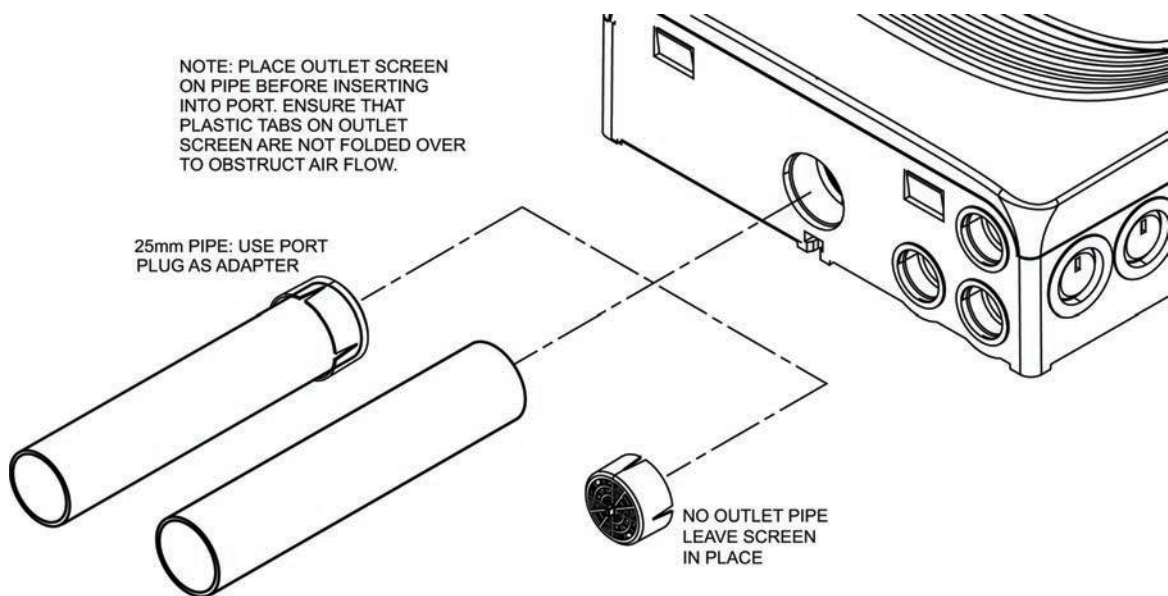

Figure 7-8: Outlet Piping Connections

7.7 Mounting the Unit

The FAAST FLEX is mounted on any wall or flat surface that is conveniently located for access to the piping and electrical connections. It can be mounted in the standard orientation or inverted 180°. Once the proper location has been determined, mount the device as follows:

Note: The FAAST FLEX can be mounted with either two or four screws, depending on your specific requirements.

1. The cover of the box FAAST FLEX, a template for the mounting holes is provided (see Figure 7-9).
2. Use the template to mark the locations for the mounting holes, ensuring that all piping and electrical connections are located properly.

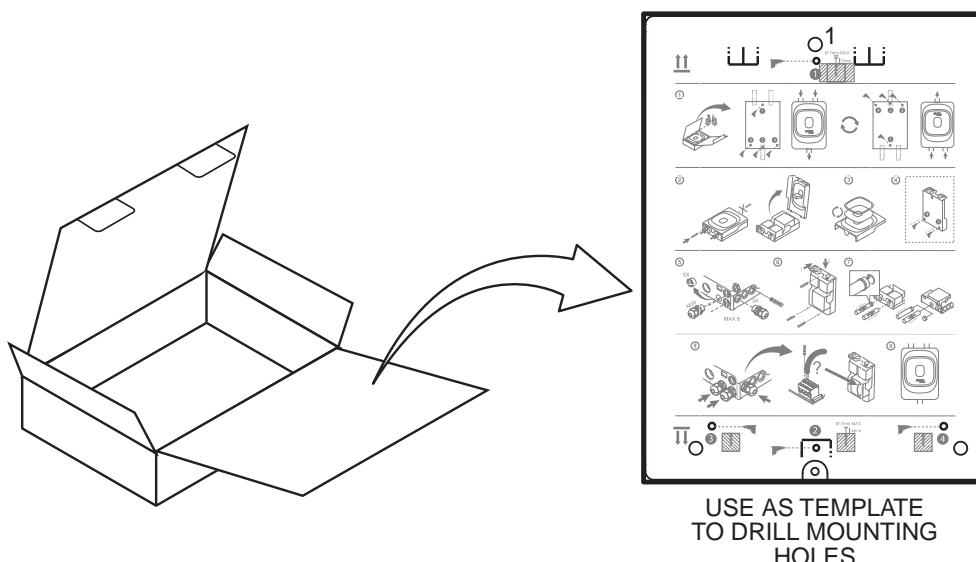

Figure 7-9: Mounting Template

3. Drill appropriate pilot mounting holes for M4 screws in the locations designated by the template.
4. Loosely install a screw in the Hole 1 location.
5. Position the FAAST FLEX in place over the mounting screw in Hole 1 (Figure 7-10) , and slide it down into place.
6. Install a mounting screw in Hole 2.
7. Tighten the two mounting screws, taking care not to overtighten. Over tightening the screws can damage the device.
8. Optionally, install mounting screws in Holes 3 and 4.

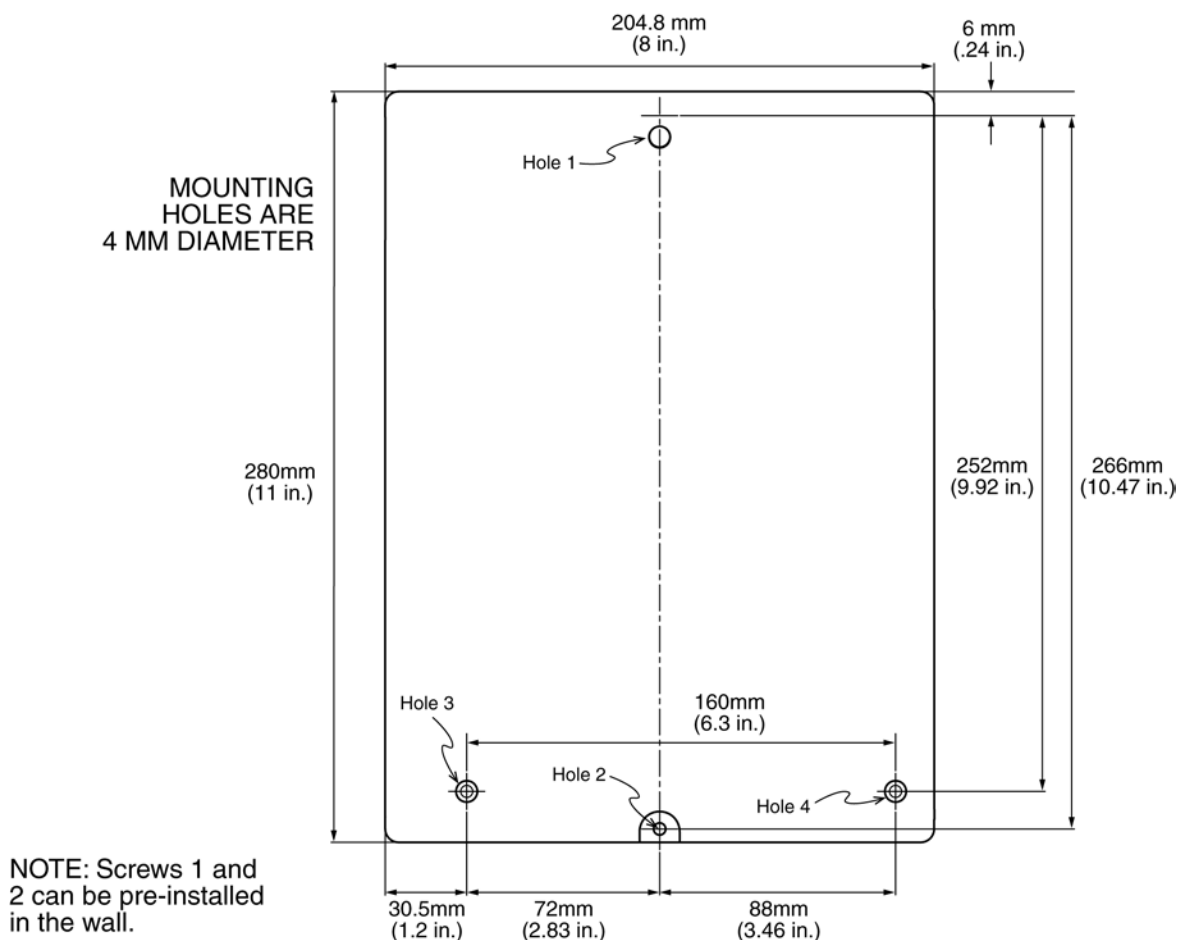

Figure 7-10: Mounting Hole Dimensions

8 Wiring Installation

8.1 Wiring Considerations

1. All wiring must comply with local requirements and regulations.
2. Panel wiring must comply with the recommendations of the panel manufacturer.
3. Always use appropriate gauge wire (10-12 gauge or 0.2 - 0.25mm). Inspect all connections to ensure they are tight and secure.
4. Remove the cover as shown in Figure 7-4.
5. Electrical connections are made to the terminal blocks as shown in Figure 9-1. Wire insulation should be stripped approximately 5mm from the end. Using a small screwdriver, push down on the small tab on the terminal block, and then insert the wire into the corresponding hole.

8.2 GPI (General Purpose Input)

One GPI is provided.

In OUT OF BOX configuration, when a transition between normal state (open) and active state (short) is detected, the device will perform a single device RESET.

9 Relay Outputs

For all the versions of the FAAST FLEX single pole, changeover, unsupervised contacts for Fault, Alarm and Action are provided for each channel. Alarm and Action relays are normally de-energized. They are switched on by the unit command. See table below for more details.

Note: In case of power down, Faults are activated. On 2 Channel models, generic fault conditions activate both channels relays.



Caution: Output channel status should be checked before powering any circuit served by the output channel itself to avoid any position change due to either shipment or installation handling.

Table 9-1: Relay Outputs

LED	Set Condition	Indications	Meaning
ALARM 1 / 2	Alarm condition reached	LATCHED: Alarm reset sequence from user	
		UNLATCHED: Alarm condition ended	
ACTION 1 / 2	Action condition reached	LATCHED: Action reset sequence from user	
		UNLATCHED: Action condition ended	
FAULT 1 / 2	One or more Fault condition(s) involving one or both channels are recognized	LATCHED: Fault reset sequence from user	i.e. Flow or sensor communication faults involve the corresponding channel; aspirator fault involves both channels
		UNLATCHED: Fault condition ended	

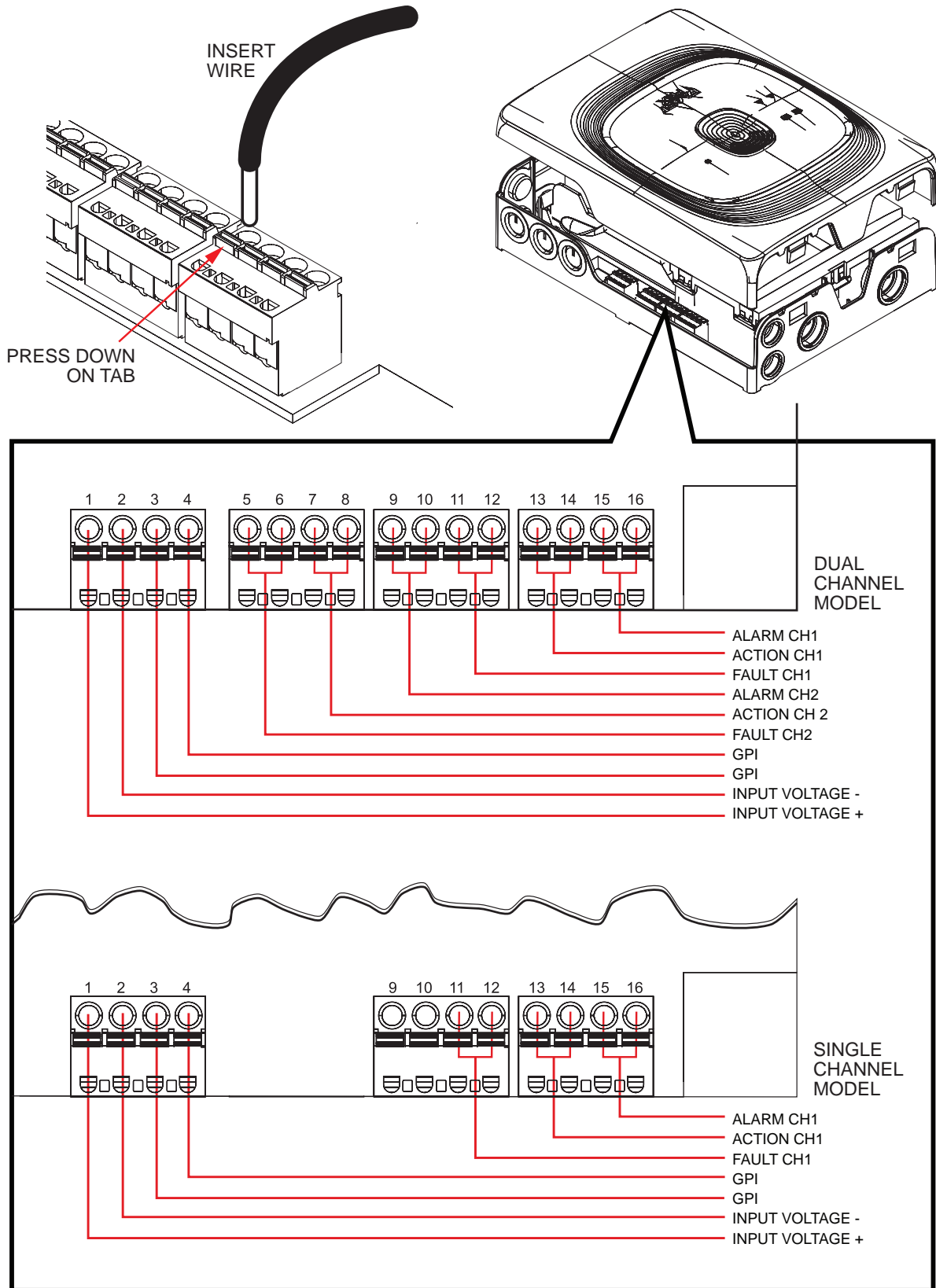
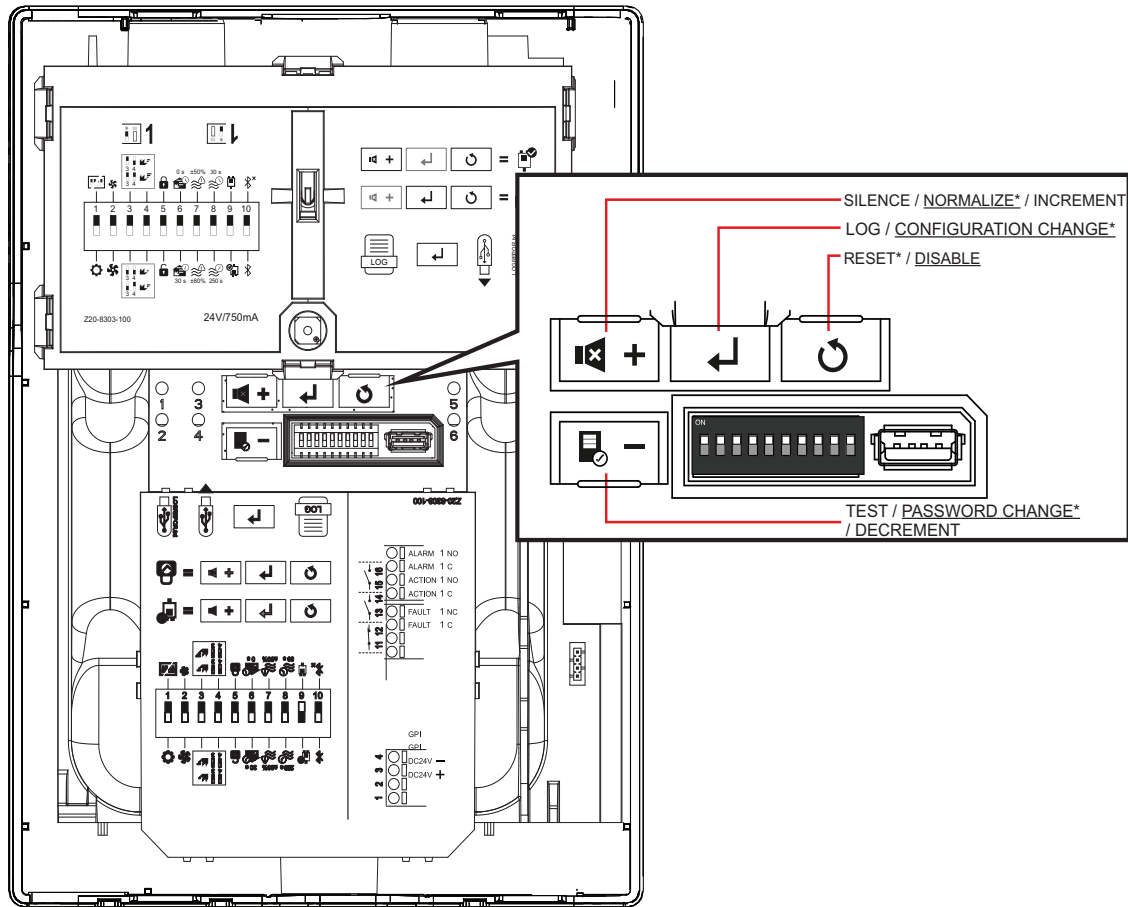

Figure 9-1: Wiring Connections

10 User Interface

There are four buttons located under the cover that are used to configure various operating parameters and perform additional setup, data logging, and test functions (see Figure 10-1).



- *: Change the passcode to start the procedure.
- **Underlined**: Press and hold the button for 5 seconds to start the procedure.

Figure 10-1: User Buttons

11 Working Modes

Figure 11 illustrates the working modes of the device. In normal operation when the device is powered on it will initialize for 60 seconds and then it will enter NORMAL operating mode. If the cover opened, or if the cover is off when it is powered on it will enter WAIT mode. Closing the cover will return the device to NORMAL mode. Figure

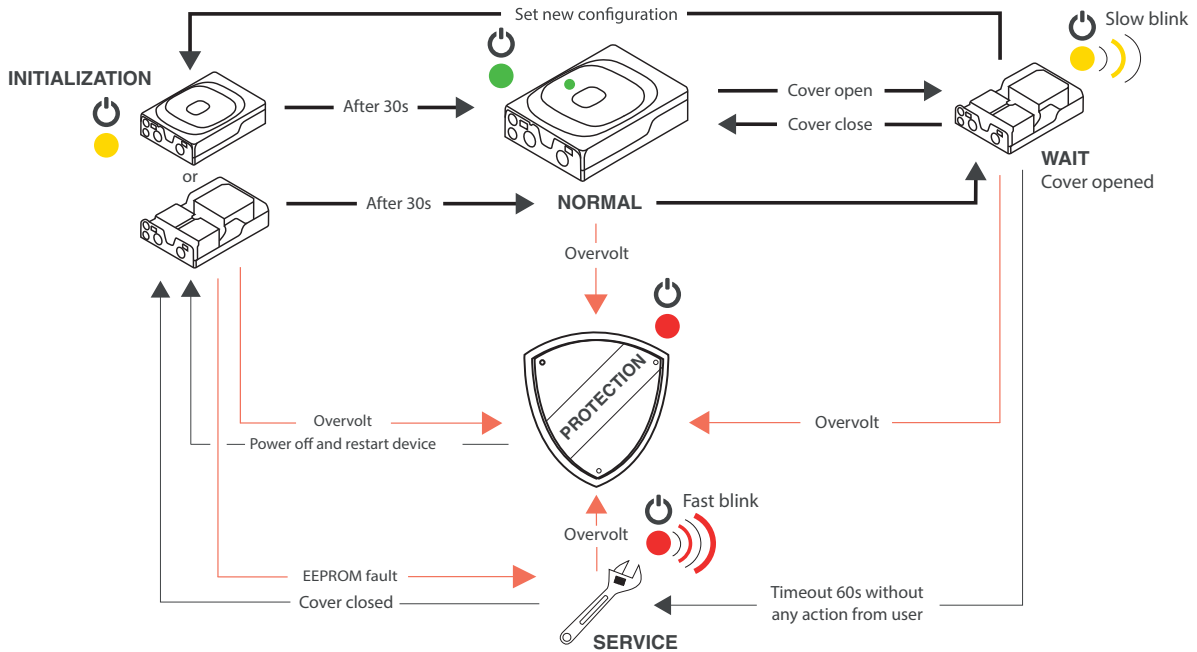

Figure 11-1: Working Modes

11.1 INITIALIZATION Mode

After the power up, the device performs an initialization sequence with the following actions, during which the POWER LED is on steady yellow.

- Checks power supply.
- Tests peripheral equipment connected to the device.
- Reads the EEPROM and DIP switch positions for configuration.

If there is a conflict between the DIP switch positions and the EEPROM values, the next step depends on whether the cover is open or closed.

1. If the cover is open, the device will prompt the user to enter the password in order to accept the new DIP switch position changes.
2. If the cover is closed The device enters the “waiting for cover” mode where, for 60 seconds, FAULT LED will blink fast yellow. If the cover is opened within this 60 second period, the device will prompt the user for password and will accept changes that have been made.
If the cover is not opened within the 60 second window, the device will signal a configuration fault and will turn on the buzzer for 0.5 every time the cover is opened or closed

If the device has been configured to use the extended mode, at the end of initialization the FAULT LED blinks fast green for 3 seconds before changing - either to WAIT mode if the cover is open, or to NORMAL mode if the cover is closed.

11.2 PROTECTION Mode

The device goes in PROTECTION in the following situations:

- EEPROM fault (from initialization mode only)
- Dataflash fault
- Power supply overvoltage

In PROTECTION mode, the POWER LED is steady red. The device switches off all peripherals and communications. The only way to exit PROTECTION mode is to completely power off the device and then power it back up.

11.3 SERVICE (or STANDBY) Mode

If cover is left open more that 60 seconds the device enters SERVICE Mode. The POWER LED blinks red (fast blink). This mode is typically used during hardware maintenance, for example changing or cleaning a filter screen in the field. During this working mode (also referred to as STANDBY Mode), the device switches off the aspirator, stops monitoring flows and sensing elements. No alarms or faults will be shown on the LEDs, relays (fault relays energized), or buzzer.

Additionally, USB and buttons sensing are turned off while Bluetooth is enabled to report Service mode only. From the SERVICE mode, users can initiate the password recovery process.

11.4 NORMAL Mode

This is normal working mode. The device monitors the power supply voltage, aspirator speed, smoke levels, air flows, cover status, and signals and logs faults, actions, alarms.

11.5 WAIT Mode

The WAIT mode is a sub-mode of the NORMAL mode. There are two ways to enter into the WAIT mode:

1. If the cover is open the device enters WAIT mode after power-on and initialization.
2. If the cover is opened while the device is in NORMAL mode.









On entering WAIT Mode the communication (loop) is interrupted and the POWER LED blinks yellow (slow blink). At this point the device is waiting for a button press.

















After 60 seconds of no activity in WAIT mode the device will automatically transition into the SERVICE mode. Every time an action (button or BLT) is performed in WAIT mode the timeout timer restarts. If a non-protected action (no passcode required) is requested, the command is executed and then the device comes back to WAIT mode. If a protected action (passcode required) is requested, user is prompted to enter the passcode. If the passcode is correct the device will perform the requested action.

WAIT Mode Actions

Note: For a long press of a button, press and hold it for 5 seconds.

Table 11-1: WAIT Mode Actions

Action	Button	LED Display	Description
Toggle button beeps ON/OFF	Short Press 	     	LED 6 will show green for ON. Default is beeps OFF.
Place unit in TEST Mode	Short Press 		See section 15 Test Mode for more information
Copy LOGREPOR.TXT to USB drive	Short Press 		USB drive must be inserted. See section 21 Event Logs for more information.

Action	Button	LED Display	Description
Reset active Alarms or Faults <i>(Passcode Authentication Required)</i>	Short Press 		Resets the latched alarm and faults status.
Toggles DISABLE Mode ON/OFF	Long Press 	     	LEDs 1 through 4 will show yellow to indicate unit is disabled.
Enter CHANGE CONFIGURATION MODE <i>(Passcode Authentication Required)</i>	Long Press 	     	LEDs 1 through 4 will show yellow to indicate unit is in configuration mode. See section 14 Configuration.
Initiate NORMALIZE procedure <i>(Passcode Authentication Required - if not authenticated, you must enter the passcode to start procedure.)</i>	Long Press 		LEDs 1 through 4 will show yellow to indicate that the NORMALIZE procedure has started. See section 16 Normalize.
Initiate CHANGE PASSWORD procedure <i>(Passcode Authentication Required - if not authenticated, you must enter the passcode to start procedure.)</i>	Long Press 		LEDs 1 through 4 will show yellow to indicate that the CHANGE PASSWORD procedure has started. See section 11.6 DISABLED Mode for more information.

11.6 DISABLED Mode

When the device is put into DISABLED mode it will not report any alarm or fault conditions via the relays. LED functions will remain active. To indicate that the device is in DISABLED mode all the LEDs will slow flash yellow (once every 10 seconds). To disable the device, long press (5 seconds) the RESET button. LEDs 1, 2, 3, and 4 will show steady yellow to confirm the command. Repeating this procedure will return the device to normal operation. **Powering off the device will NOT exit DISABLED mode.**

12 Changing the Passcode



Caution: THE DEFAULT PASSCODE IS 000000 AND IT MUST BE CHANGED DURING DEVICE COMMISSIONING! BE SURE TO RECORD THE NEW PASSCODE IN ACCORDANCE WITH YOUR LOCAL POLICIES.

Overview





Certain actions related to operation and configuration of the FAAST FLEX are protected by use of a passcode. To enter the passcode, the user must press the SILENCE/+ or TEST/- buttons to enter the six digits of the passcode. Once the digit has been entered, press the ENTER button to confirm the digit. For example, to enter a 3 you would press the SILENCE/+ button three times. If you pressed the SILENCE/+ button four times, and then pressed the TEST/- button once, that would also register as a 3. Once all six digits have been entered, press the ENTER button again to confirm entry.

Example - Changing Passcode from 000000 to 123456

To change the passcode you must first enter the current passcode. Then you must enter the new passcode, and then re-enter the new passcode a second time to confirm that it is correct. The following procedure demonstrates changing the passcode from 000000 to 111111.

1. Long-press the TEST button to enter the CHANGE PASSCODE mode. LEDs 1, 2, 3 and 4 will flash yellow, and then LED 1 will show steady yellow indicating that the device is waiting for entry of the first digit.

Note: The digit counter starts at 0, so pressing the ENTER button will record 0 as the current digit. The following table summarizes the actions of button presses during the procedure.

Button		Action(s)
SILENCE/+		Increments the current digit (if smaller than 9).
TEST/-		Decrements the current digit (if greater than 0).
RESET		Cancels changes to the current digit entry and prompts for the user to re-enter the digit.
ENTER		Confirms the current digit and the corresponding LED shows yellow. If all six digits have been confirmed and are correct, all LEDs will show green. If incorrect, all LEDs will show red for 3 seconds.

2. Press the ENTER button six times to enter the default passcode (000000). Each time you press the ENTER button, the LED corresponding to that digit will show steady yellow indicating the digit has been entered. Once the sixth digit is entered, all six LEDs will show steady yellow.
3. Press the ENTER button again to confirm the passcode entry. The LEDs will all show green for five seconds, then will go out.
4. LED 1 will show steady yellow, prompting you for the first digit of the new passcode. Enter the new passcode as follows:
 - a. Press the SILENCE/+ button one time to enter 1 as the first digit. LED 1 will flash green as you press the SILENCE/+ button.
 - b. Press the ENTER button to enter the first digit. LED 1 will show steady yellow.
 - c. Press the SILENCE/+ button twice to enter 2 as the second digit. LED 2 will flash green as you press the SILENCE/+ button.
 - d. Press the ENTER button to enter the second digit. LED 1 and LED 2 will show steady yellow.
 - e. Press the SILENCE/+ button three times to enter 3 as the third digit. LED 3 will flash green as you press the SILENCE/+ button.
 - f. Press the ENTER button to enter the third digit. LEDs 1, 2, and 3 will show steady yellow.
 - g. Press the SILENCE/+ button four times to enter 4 as the fourth digit. LED 4 will flash green as you press the SILENCE/+ button.
 - h. Press the ENTER button to enter the fourth digit. LEDs 1, 2, 3 and 4 will show steady yellow.

- i. Press the SILENCE/+ button five times to enter 5 as the fifth digit. LED 5 will flash green as you press the SILENCE/+ button.
 - j. Press the ENTER button to enter the fifth digit. LEDs 1, 2, 3, 4, and 5 will show steady yellow.
 - k. Press the SILENCE/+ button six times to enter 6 as the last digit. LED 6 will flash green as you press the SILENCE/+ button.
 - l. Press the ENTER button to enter the last digit. All LEDs will show green for 5 seconds, and then will go out.
5. Repeat the procedure in step 4 to re-enter and confirm the new passcode.

Note: After three failed attempts to enter the passcode, the unit will return to WAIT mode. The user must wait 20 seconds before attempting to re-enter the passcode. Each subsequent attempt will increase the wait time by an additional 20 seconds.

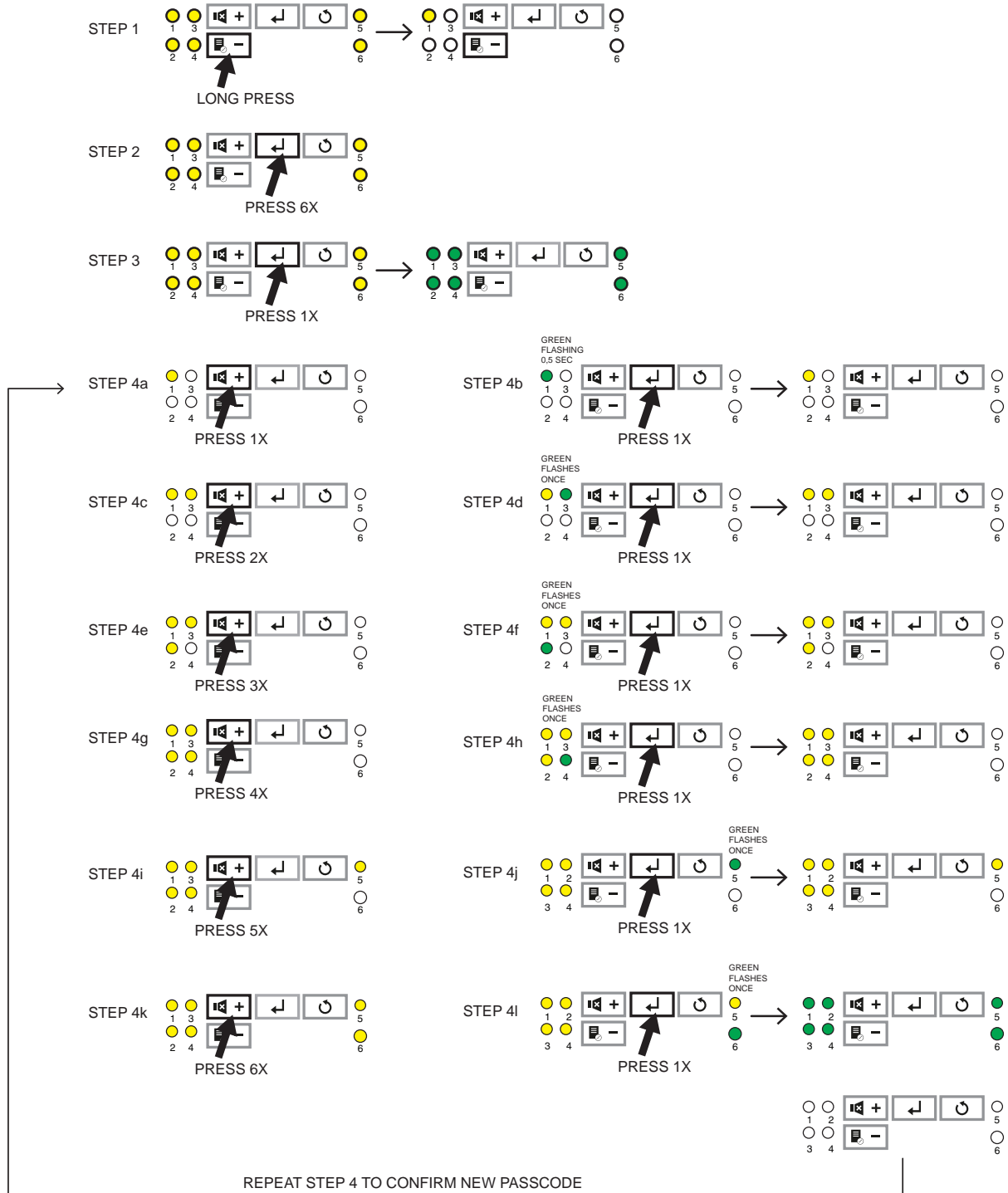

Figure 12-1: Changing Passcode

13 Authenticating - Entering Passcode

Access to some functions requires a passcode. Follow these steps to enter the passcode (see Figure 13-1):

Note: Passcodes are 6 digits long and digits from 0 to 9 are valid.

1. When you access a function that requires authentication, all the LEDs will blink YELLOW 3 times, indicating that you need to enter a valid passcode.
2. Using the SILENCE/+ or TEST/- buttons, enter the first digit of the passcode.
3. Press the ENTER button to confirm the first digit. LED 1 will be steady yellow and LED 2 will blink slow yellow.
4. Repeat the process until all six digits of the passcode have been entered.
5. After the sixth digit has been entered, if the passcode is correct all six LEDs will show steady green for 3 seconds. If the passcode is incorrect, all six LEDs will show steady red for 3 seconds and the process must be restarted.

EXAMPLE: PASSCODE IS 794231

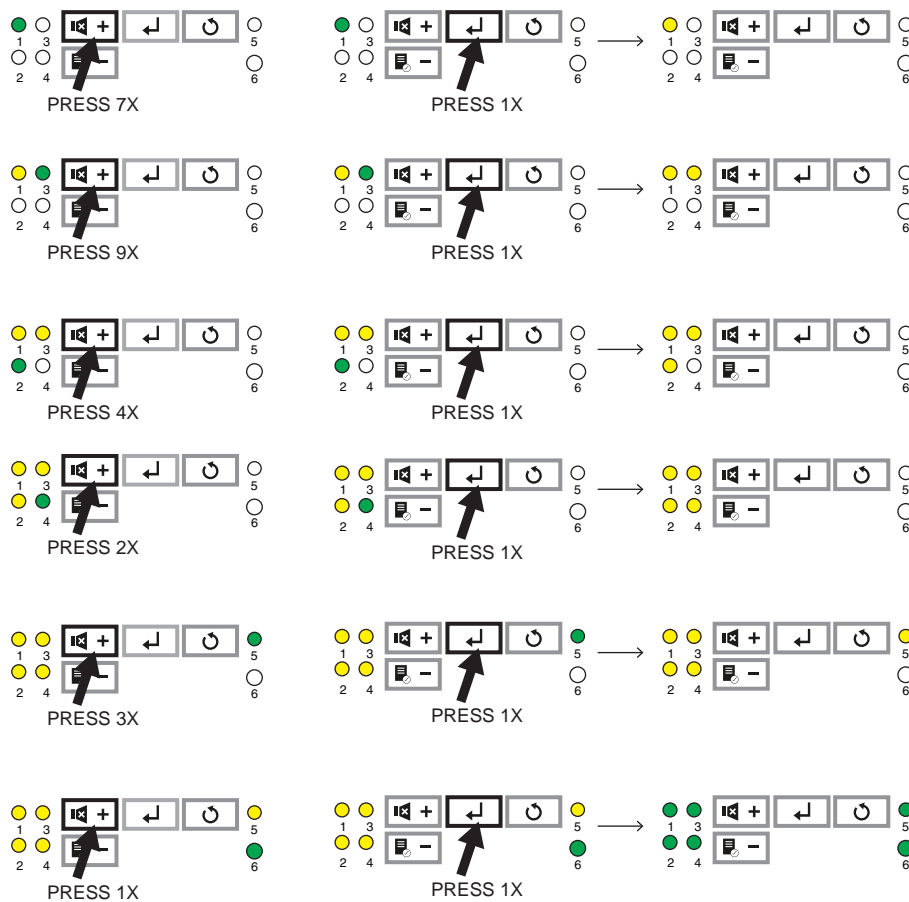

Figure 13-1: Entering Passcode Example

14 Configuration

14.1 Configuration Modes

The FAAST FLEX can be configured by two methods. Typical installations are configured using a DIP switch (see Figure 14-1). For custom installation, an Extended Configuration mode is available. In Extended Configuration mode, configuration information is stored in an on-board EEPROM. A guide to DIP switch configuration options is etched on the internal covers of the aspirator and sensors, as shown.

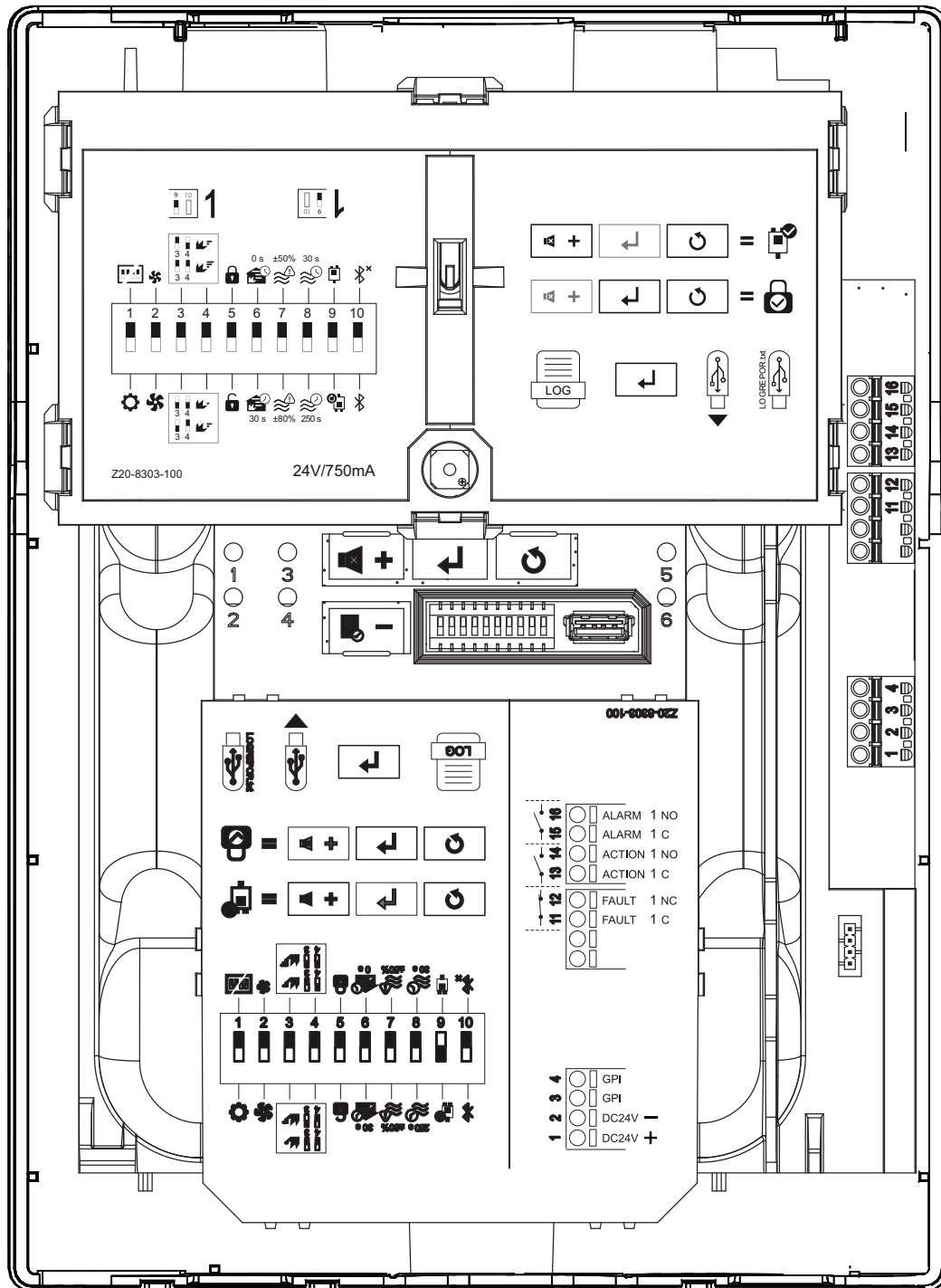

Figure 14-1: Configuration Laser Etching

Note: Default setting for all DIP switches is ON.

14.2 DIP Switch Configuration

Table 14-1: DIP Switch Configuration

Switch	Icon	Setting	Position	Description
1		Configuration Mode	ON	Enables configuration using DIP switches
			OFF	Disables configuration using DIP switches
2		Aspirator Speed	ON	LOW aspirator speed
			OFF	HIGH aspirator speed
3 and 4		Alarm Level (See Table 14-2 for more information on Alarm Levels)	ON, ON	HIGH: Alarm = Level 1, Action = Level 0
			ON, OFF	MEDIUM: Alarm = Level 3, Action = Level 2
			OFF, ON	MEDIUM: Alarm = Level 3, Action = Level 2
			OFF, OFF	LOW: Alarm = Level 5, Action = Level 4
5		Alarm/Action/Fault	ON	Unlatched
			OFF	Latched
6		Alarm Mode	ON	Instant Fire
			OFF	Cumulative, Action delay 30 seconds and Alarm delay 30 seconds
7		Flow Fault Threshold	ON	Apply flow fault criteria policy $\pm 20\%$ reference flow
			OFF	$\pm 50\%$
8		Flow Fault Delay	ON	30 seconds
			OFF	300 seconds
9		Detector Orientation	ON	Upright
			OFF	Inverted
10		Bluetooth Functionality	ON	Disabled
			OFF	Enabled

Table 14-2: Smoke Levels Description

Alarm Level	Description	Obscuration Detected		Notes
		Imperial Units	Metric Units	
1	EEPROM error			
5-8	Photo sample fault			s/a 0 = 5 light compensation fail s/a 0 = 6 photo offset low or high s/a 0 = 7 light start minus dark start > max s/a 0 = 8 negative photo sample s/a 0 = 9 photo sample interrupted or ADC time/out
40 ... 50	Normal			Drift Level: 50 =clean, 40 =100% drift
110	Alarm level 0	70% of level 1	70% of level 1	Action if Alarm level configured as HIGH in Out of box Mode
120	Alarm level 1	0.02 % obs/ft	0.07 % obs/m	Alarm if Alarm level configured as HIGH in Out of box Mode
130	Alarm level 2	0.03 % obs/ft	0.10 % obs/m	Action if Alarm level configured as MEDIUM in Out of box Mode
140	Alarm level 3	0.05 % obs/ft	0.16 % obs/m	Alarm if Alarm level configured as MEDIUM in Out of box Mode
150	Alarm level 4	0.10 % obs/ft	0.33 % obs/m	Action if Alarm level configured as LOW in Out of box Mode
160	Alarm level 5	0.20 % obs/ft	0.66 % obs/m	Alarm if Alarm level configured as LOW in Out of box Mode
170	Alarm level 6	0.50 % obs/ft	1.64 % obs/m	Not approved under EN54-20 regulatory
180	Alarm level 7	1.00 % obs/ft	3.28 % obs/m	Not approved under EN54-20 regulatory
190	Alarm level 8	1.50 % obs/ft	4.92 % obs/m	Not approved under EN54-20 regulatory
200	Alarm level 9	2.00 % obs/ft	6.56 % obs/m	Not approved under EN54-20 regulatory

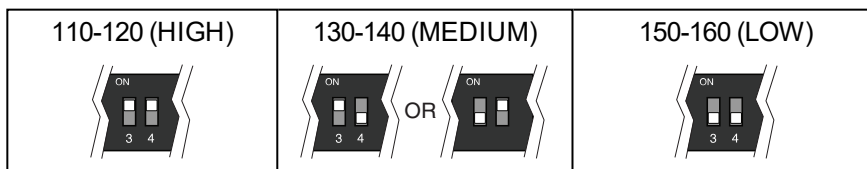

Note: The HIGH, MEDIUM, and LOW levels correspond to the settings of DIP Switches 3 and 4.

About Faults, Alerts, and Alarms

The unit can signal two types of abnormal conditions: alerts (minor issues) and faults (major issues). Faults are indicated by the FAULT LED showing yellow, either blinking or steady ON. Some alerts or faults are common to both channels (e.g. aspirator fault), whilst others are only related to channel 1 or channel 2 for 2-channel devices (e.g. sensing head fault). If one or more faults occur, the FAULT LED indicates the most important fault, and the fault relays are activated accordingly. Faults can be either latched or not, based on configuration. If latched, the user must manually clear the fault by pressing the RESET button. User can configure (EXTENDED mode) a delay between fault condition and fault relay activation (default is 60 seconds) during which activation is aborted if the fault condition terminates. In 2 channel models, if a fault is

related to both channels both relays are activated. The device logs all alerts and faults as well as the exit from fault or alert conditions. Alarms are raised when smoke levels exceed the limits established by the device configuration.

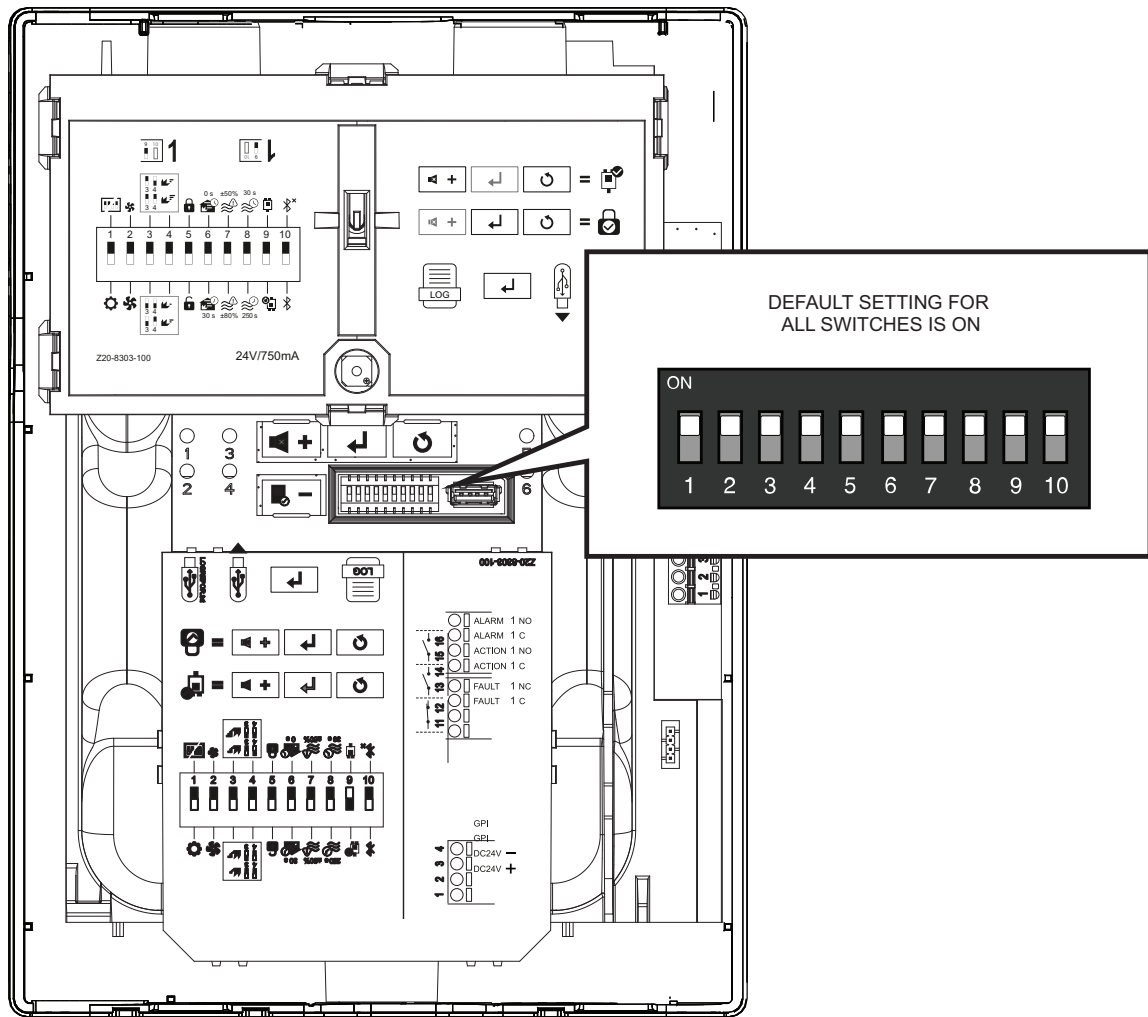

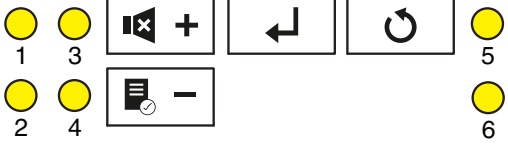
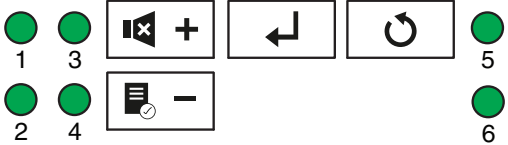

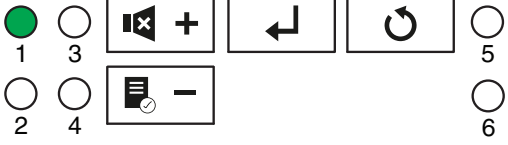

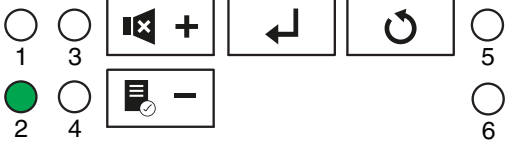



Figure 14-2: Configuration DIP Switches

14.3 Changing Configuration Mode

There are two configuration modes for the device. In DIP SWITCH Mode the operational parameters are determined by the position of the DIP switches. In EXTENDED mode the operational parameters are determined by the EEPROM. EXTENDED mode is typically used for custom installations. Follow these steps to switch between the two modes:

















































































Action	Button	LED Display	Description
While the unit is in WAIT mode, long press the ENTER button.	Long Press 		All LEDs will flash yellow and then go out.
Enter the current passcode.			After passcode is entered correctly, all LEDs will show green. See section 13 Authenticating - Entering Passcode.
Change DIP switch settings as desired.			See section 14 Configuration for details.
Increment current hour by 30 minutes (for a max of +14 hours)	Short Press 		LED 1 blinks green every time user presses the button.
Decrement current hour by 30 minutes (for a max of -14 hours).	Short Press 		LED 3 blinks green every time user presses the button.
Press the ENTER button. The new configuration is saved and the device exits configuration mode.	Long Press 		The device will restart with the new configuration active.

15 Test Mode

In TEST mode, the device will perform a self-test. As tests are executed the user must confirm each step of the test before it continues.

Follow these steps to enter TEST mode execute the self-test.

Note: If any of these steps do NOT complete correctly, press the SILENCE/+ button to indicate FAIL condition for the test step.

Action	Button	Action(s)	Description
While the device is in WAIT mode, long press the TEST button. /+	Short Press 	        	All LEDs will show red in the following sequence: 1, 3, 5, 6, 4, 2.
Press the TEST button to confirm test PASS.	Short Press 	        	All LEDs will show green in the following sequence: 1, 3, 5, 6, 4, 2.
Press the TEST button to confirm test PASS.	Short Press 	        	Buzzer will sound for 1 second and all LEDs will show yellow in the following sequence: 1, 3, 5, 6, 4, 2.
Press the TEST button to confirm test PASS.	Short Press 	        	LED 5 shows green, indicating normal condition (no action/alarms or faults).
Press the TEST button to confirm test PASS.	Short Press 	        	LED 3 shows red to indicate Action condition on Channel 1.
Press the TEST button to confirm test PASS.	Short Press 	        	LED 6 shows yellow to indicate Fault condition on Channel 1.
Press the TEST button to confirm test PASS.	Short Press 	        	LED 4 shows red to indicate Action condition on Channel 2. (Test step must be completed even on Single Channel units.)
Press the TEST button to confirm test PASS.	Short Press 	        	LED 2 shows red to indicate Alarm condition on Channel 2. (Test step must be completed even on Single Channel units.)

Action	Button	Action(s)	Description
Press the TEST button to confirm test PASS.	Short Press 	LED 1, 2, 3, 4, 5, 6	LED 6 shows yellow to indicate Fault condition on Channel 2. (Test step must be completed even on Single Channel units.)
Press the TEST button to confirm test PASS.	Short Press 	LED 1, 2, 3, 4, 5, 6	All LEDs show green if all tests PASS. All LEDs show red if any step in FAILs.
Press the RESET button to exit TEST mode or Insert a USB drive and press the ENTER button to download test results.	Short Press Short Press 		The results of the test will be written to the USB drive with the filename DIAGTEST.txt and the device will beep to provide an audible confirmation that the process is complete.

DIAGTEST.TXT File Format



















The DIAGTEST.TXT file will contain the result of the test in the format shown below.

1CH	2CH
SELF_TEST_RED_LIGHT_PASSED	SELF_TEST_RED_LIGHT_PASSED
SELF_TEST_GRE_LIGHT_PASSED	SELF_TEST_GRE_LIGHT_PASSED
SELF_TEST_YEL_LIGHT_PASSED	SELF_TEST_YEL_LIGHT_PASSED
SELF_TEST_NORMALSTA_PASSED	SELF_TEST_NORMALSTA_PASSED
SELF_TEST_ACTIO_CH1_PASSED	SELF_TEST_ACTIO_CH1_PASSED
SELF_TEST_ALARM_CH1_PASSED	SELF_TEST_ALARM_CH1_PASSED
SELF_TEST_FAULT_CH1_PASSED	SELF_TEST_FAULT_CH1_PASSED
SELF_TEST_ACTIO_CH2_NOTAVA	SELF_TEST_ACTIO_CH2_PASSED
SELF_TEST_ALARM_CH2_NOTAVA	SELF_TEST_ALARM_CH2_PASSED
SELF_TEST_FAULT_CH2_NOTAVA	SELF_TEST_FAULT_CH2_PASSED

16 Normalize

Normalize procedure is used to adjust the flow reference to the current flow aspirated by the device.

Note: Before starting the NORMALIZE procedure, the pipe system should be connected and checked. There can be no blockages, open pipes, dirty filters, dust, or other obstructions. The device should be working for 1 minute and air flow must be stable.

Action	Button	LED Display	Description
While the device is in WAIT mode, long press the SILENCE/+ button. (Enter the current passcode.)	Long Press 	  1 3   2 4  LED 5 slow blink yellow 5  LED 6 fast blink red 6	LED 6 will flash red until the procedure is complete.
Once the NORMALIZE procedure is complete, the buzzer will sound for 0.5 seconds. LED 6 will indicate the result.		  1 3   2 4  5  6	LED 6 will show green if the NORMALIZE procedure completed successfully.
		  1 3   2 4  LED 5 slow blink yellow 5  LED 6 fast blink red 6	LED 6 will show red if the NORMALIZE procedure was unsuccessful.
Unit will return to WAIT mode.			



Note: If the cover is closed during the NORMALIZE procedure, then the procedure is aborted and the device will return to WAIT mode.

17 Resetting Alarms and Faults

To reset any alarm and/or fault conditions press the RESET button. You will be prompted to enter the passcode. Once the passcode has been successfully entered, all latched alarms and faults are reset (both LEDs and relays) and the device returns to WAIT mode.

18 EEPROM Factory Reset

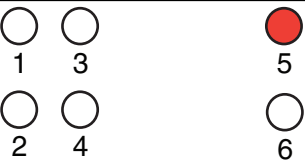
To perform a reset to the default EEPROM configuration, perform the following steps.

Action	Button	LED Display	Description
Open cover and allow device to enter SERVICE Mode (60 second wait).			LED 5 will flash red when the device enters SERVICE Mode.
Set all DIP Switches to ON position.			
Long press the RESET button.	Long Press 		LED 5 will go out and LEDs 1, 2, 3, and 4 will flash yellow, and the buzzer will sound to indicate that the reset procedure has been started.
Enter the passcode.			Once the passcode is entered, the device will be reset to the EEPROM factory settings. Note: The passcode is NOT changed.



All LEDs will show green for 2 seconds to indicate the reset was successful.

If the LEDs show red, repeat the process by long pressing the RESET button again. This can happen in an undervoltage situation.

Note: If the reset procedure fails a second time the device is corrupted and must be replaced with a new unit.

19 Passcode Recovery

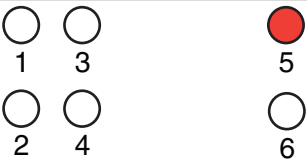
In the event the passcode has been lost, perform the following steps to recover the passcode .

Action	Button	LED Display	Description
Open cover and allow device to enter SERVICE Mode (60 second wait).			LED 5 will flash red when the device enters SERVICE Mode.
Plug a formatted USB drive into the port.			
Long press the ENTER button.	Long Press 		LED 5 will go out and LEDs 1, 2, 3, and 4 will flash yellow, and the buzzer will sound to indicate that the reset file has been written to the USB drive.
Email the file from the USB drive to your device supplier. The passcode will be recovered by Honeywell Customer Support and will be communicated by the vendor back to you via email or telephone.			

20 Maintenance

20.1 Sensor Replacement



Warning: Working on the FAAST FLEX with power applied can result in electrical shock hazard. Input power must be disconnected from the device before any performing any maintenance. Remove power from the device by opening the appropriate circuit breaker(s) or turning the power supply off.

1. Remove cover (see Figure 7-4).

Note: The sensor cover and the rubber gasket may stick together when removing the sensor cover. Some effort may be required to pull the sensor cover off.

2. Using a small screwdriver, release six locking tabs, and remove Sensor Cover (see Figure 20-1).
3. Press two latches inward to release sensor, and remove Sensor.
4. Install replacement Sensor.
5. While pressing down on Sensor, push two latches outward to lock Sensor in place.
6. Replace Sensor Cover and press down to engage locking tabs.
7. Check and ensure that all six tabs are secured.
8. Replace cover.

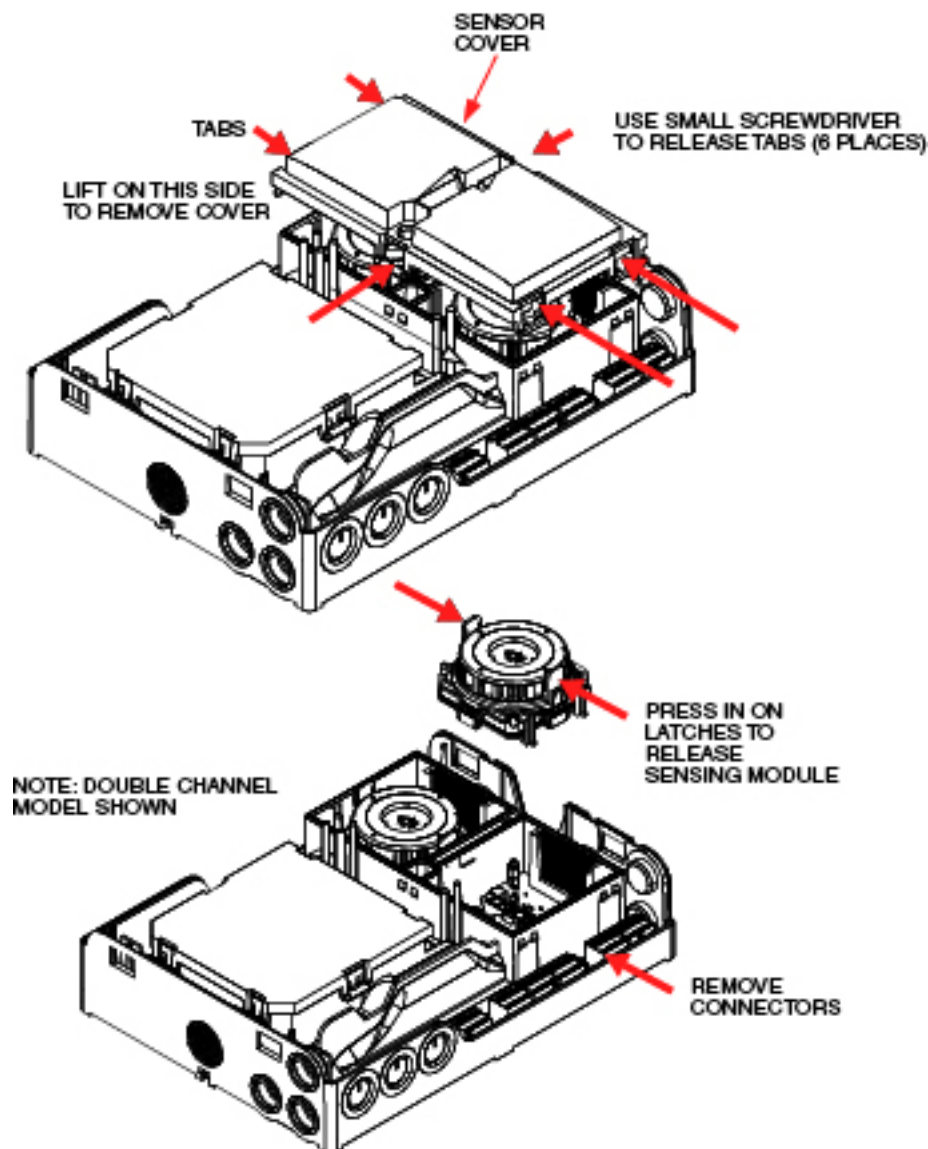

Figure 20-1: Sensor Replacement

20.2 Aspirator Replacement



Warning: Working on the FAAST FLEX with power applied can result in electrical shock hazard. Input power must be disconnected from the device before any performing any maintenance. Remove power from the device by opening the appropriate circuit breaker(s) or turning the power supply off.

1. Remove cover (see Figure 7-4).
2. Using a small screwdriver, release six locking tabs, and remove Aspirator Cover (see Figure 20-2).

Note: Take note of the orientation of the Aspirator and the cable when removing.

3. Disconnect aspirator connector and remove Aspirator.
4. Connect aspirator connector to header, and install replacement Aspirator.
5. Replace Aspirator Cover and press down to engage locking tabs.
6. Check and ensure that all six tabs are secured.
7. Replace cover.

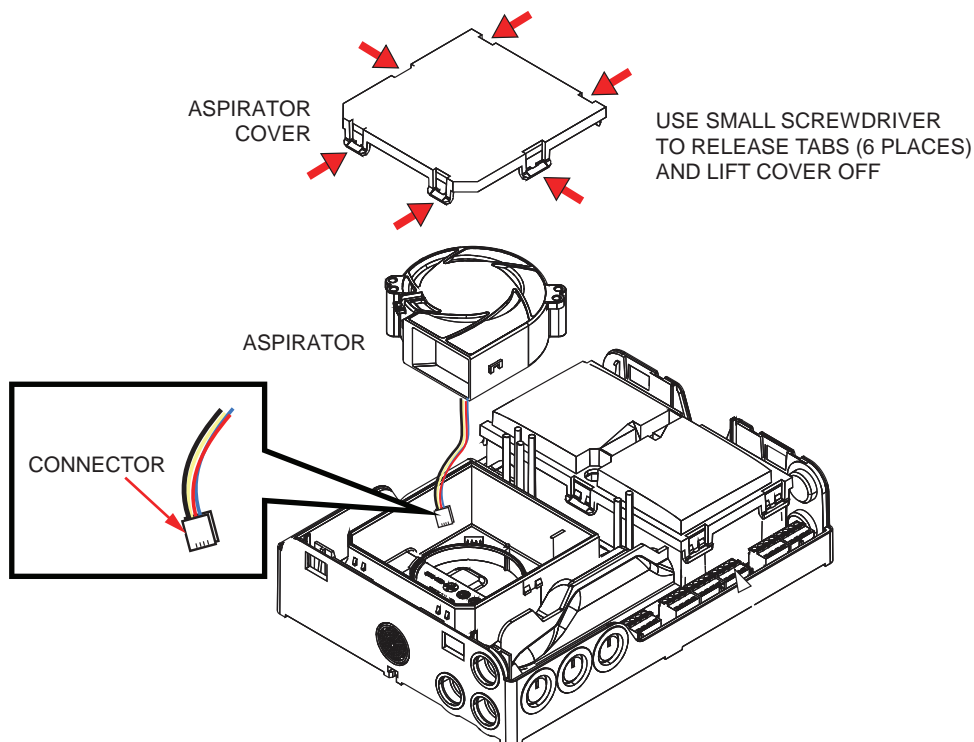

Figure 20-2: Aspirator Replacement

20.3 Filter Replacement

The FAAST FLEX has two filters to prevent dirt and debris from entering the Sensors, and a third filter on the air outlet. Filters should be replaced annually to ensure proper operation.



Warning: Working on the FAAST FLEX with power applied can result in electrical shock hazard. Input power must be disconnected from the device before any performing any maintenance. Remove power from the device by opening the appropriate circuit breaker(s) or turning the power supply off.

Note: In harsh operating environments (excessive dust, insects, exposure to chemicals) the filter screens may need to be replaced more frequently.

During maintenance, the sensors should be protected whenever the filters are removed. The shipping box is designed with four cardboard protection tabs that can be removed and inserted in place of the filters to provide protection. See Figure 20-3.

1. Remove cover (see Figure 7-4).
2. Using a small screwdriver, release six locking tabs, and remove Sensor Cover (see Figure 20-3).
3. Using a small screwdriver, release six locking tabs, and remove Aspirator Cover.
4. Remove Channel 1 Filter, Channel 2 Filter, and Outlet Filter.
5. Replace Aspirator Cover and press down to engage locking tabs.
6. Replace Sensor Cover and press down to engage locking tabs.
7. Replace cover.

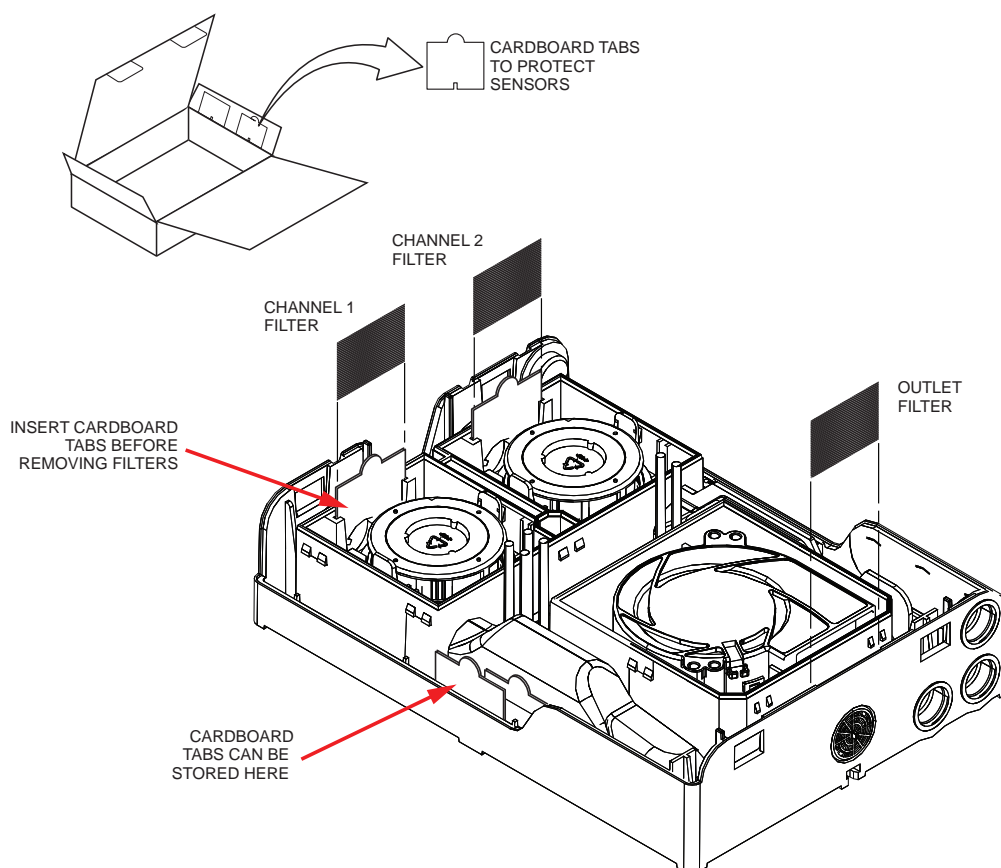

Figure 20-3: Filter Replacement

21 Event Logs

Follow these steps to download event log files to a USB drive:

Note: The USB drive must be formatted in FAT32 format, and must be completely empty, and the volume name must be no more than seven characters.

1. While the device is in WAIT mode, press the ENTER button and insert the USB drive. The device will sound a buzzer once the LOGREPOR.TXT file is downloaded.
2. Once the log file is written, the FAULT LED will show red for negative feedback or green for positive feedback. Remove the USB drive. The USB drive will contain a new log file, named LOGREPOR.TXT.

Data Log Header

Figure 21 shows the header of the LOGREPOR.TXT log file. The table below describes the information contained the log.

```

FAAST FLEX Diagnostic YY-MM-DD HH:MM
-----
--INFO-----
Model type       : Stand alone
Number of channels :      2
Standard        : EN 54-20
Serial number    : 787000000000
FW version      :      0
FW major version :      0
FW minor version :      0
FW build version :      0
HW version      :      0

--Manufacturing date GMT-----
DAY             :      0
MONTH          :      0
YEAR           :      0
HOUR           :      0
MINUTE        :      0

--SETTINGS-----
Configuration    : Out of the box
Last good DipSW conf: 1111111111
Detector orientation: Upright
Alarm level     :      1
Action level    :      0
Reference flow 1 :      40 l/min
Minimum flow 1  :      32 l/min
Maximum flow 1  :      48 l/min
Reference flow 2 :      40 l/min
Minimum flow 2  :      32 l/min
Maximum flow 2  :      48 l/min
GPI open       : none
GPI close      : reset
GPI EOL=47K    : ext fault
Blower speed   :      6
Blower correction : -3 YY-MM-DD

--STATE-----
Device in fault : NO
Power supply    : 23 V
Disabled       : NO
GPI            : OPEN
Relay ALARM 1  : reset
Relay ALARM 2  : reset
Relay ACTION 1 : reset
Relay ACTION 2 : reset
Relay FAULT 1  : reset
Relay FAULT 2  : reset

Progres | Day-Month | Hour:Minute:Second | Event | Temperature 1 | Temperature 2 | Flow 1 | Flow 2 | Smoke Level 1 | Smoke Level 2 | RPM blower |
0 | 22- 4 | 23:12:00 | 1 | 25 | 24 | 39 | 42 | 50 | 50 | 3600 ||
    
```

Figure 21-1: Data Log Header

Table 21-1: LOGREPOR.TXT File Structure

Event	Description	Event	Description
0	No event	21	Normalize failed, flow out of range
1	Power on	22	Reset started
2	Cover opened	23	Change configuration request
3	Cover closed	24	Log requested
4	Password entry	25	Log downloaded
5	Password modified	26	China silence alarm
6	Password correct	27	Disable Buzzer Button EN

Event	Description	Event	Description
7	Password incorrect	28	Open cover to confirm unauthorized change configuration
8	To Disable	29	To Protection (overvolt)
9	Exit from Disable	30	To Normal
10	Test started EN	31	To Wait
11	Test completed EN	32	To Service
12	Test log written EN	33	Pairing tentative
13	China test started	34	Pairing successfully completed
14	China test completed	35	E2P factory restore success
15	GPI Reset device	36	E2P factory restore failed
16	GPI To Disable	37	Password recovery
17	GPI Exit from Disable	38	PID STARTED
18	Normalize start	39	PID over
19	Normalize successfully completed	40	Change configuration completed
20	Normalize failed, flow not stable	41	Exit from Configuration after timeout
42	Exit from Password entering for timeout		
43	Exit from Password change for timeout		
44	Hour changed		
45	Exit from Disable after timeout		
101	Configuration data not available or corrupted ¹		
102	EEPROM not readable ¹		
103	Bluetooth module error	1103	Exit from bluetooth module error
104	GPI external fault ²	1104	Exit from GPI external fault ²
105	Ch1 ultrasonic faulty circuit	1105	Exit from Ch1 ultrasonic faulty circuit
106	Ch1 sensing head communication fault	1106	Exit from Ch1 sensing head communication fault
107	Aspirator is faulty	1107	Exit from Aspirator faulty
108	Ch1 flow initialization failed	1108	Exit from ch1 flow initialization failed
109	Ch1 flow is below the min limit	1109	Exit from ch1 Low flow fault
110	Ch1 flow is above the max limit	1110	Exit from ch1 High flow fault
111	Ch2 ultrasonic faulty circuit	1111	Exit from ch2 ultrasonic faulty circuit
112	Ch2 sensing head communication fault	1112	Exit from ch2 sensing head communication fault
113	Ch2 flow initialization failed	1113	Exit from ch2 flow initialization failed
114	Ch2 flow is below the min limit	1114	Exit from ch2 Low flow fault
115	Ch 2 flow is above the max limit	1115	Exit from ch2 High flow fault
116	Power if over 31V ¹	1116	
117	Discrepancy between dip-switches position and device config	1117	Exit from EEprom config diff dip-sw fault

¹Switch into PROTECTION mode

²If GPI is configured as FAULT

Event	Description	Event	Description
118	Data Flash fault ¹		
119	EEPROM Checksum fault ²		
120	Ch1 dirt fault ³	1120	Exit from Ch1 dirt fault ⁴
121	Ch2 dirt fault ³	1121	Exit from Ch2 dirt fault ⁴
201	RTC cannot be read or set	1201	Exit from RTC alert
202	RTC data is not consistent	1202	Exit from Invalid time base alert
203	Ch1 Temperature is above the nominal threshold	1203	Exit from ch1 High temperature alert
204	Ch1 Temperature is below the nominal threshold	1204	Exit from ch1 Low temperature alert
205	Ch2 Temperature is above the nominal threshold	1205	Exit from ch2 High temperature alert
206	Ch2 Temperature is below the nominal threshold	1206	Exit from ch2 Low temperature alert
207	Supply voltage below 21V	1207	Exit from Low power alert
208	Ch1 dirt alert no.1 ⁴	1208	Exit from ch1 dirt alert no.1 ⁴
209	Ch1 dirt alert no.2 ⁵	1209	Exit from ch1 dirt alert no.2 ⁵
210	Ch2 dirt alert no.1 ⁴	1210	Exit from ch2 dirt alert no.1 ⁴
211	Ch2 dirt alert no.2 ⁵	1211	Exit from ch2 dirt alert no.2 ⁵
212	Supply voltage below EEPROM working voltage 19V	1212	Exit from No Safe Write EEPROM
301	Action ch1	1301	Exit from Action ch1
302	Alarm ch1	1302	Exit from Alarm ch1
303	Action ch2	1303	Exit from Action ch2
304	Alarm ch2	1304	Exit from Alarm ch2

¹Switch into PROTECTION mode

²Switch into SERVICE mode

³Drift level 100%

⁴Drift level 40%

⁵Drift level 70%

Log example and interpretation

HEADER reading for salient data: document downloaded from device in date Sept. 26 2021, is a double channel manufactured in date Sept 21 2021 following EN54-20 standard, DIP switches configuration all 1, reference flow 97 l/min, GPI open.

```

-----
FAAST FLEX Diagnostic  21-10-26 11:11
-----

--INFO-----
Model type       : Stand alone
Number of channels : 2
Standard        : EN 54-20
Serial number    : 000000000000
FW version       : 2.1.0
FW major version : 0
FW minor version : 0
FW build version : 0
HW version       : 1

--Manufacturing date GMT-----
DAY       : 10
MONTH     : 09
YEAR      : 2021
HOUR      : 08
MINUTE    : 25

--SETTINGS-----
Configuration    : Out of the box
Last good DipSW conf: 1111111111
Detector orientation: Upright
Alarm level      : 1
Action level     : 0
Reference flow 1 : 97 l/min
Minimum flow 1  : 83 l/min
Maximum flow 1  : 111 l/min
Reference flow 2 : 97 l/min
Minimum flow 2  : 111 l/min
Maximum flow 2  : 83 l/min
GPI open        : 0
GPI close       : 1
GPI EOL         : 0
Blower speed    : 6
Blower correction : 0 00-00-06

--STATE-----
Device in fault  : NO
Power supply     : 23.3 V
Disabled         : NO
GPI              : OPEN
Relay ALARM 1   : reset
Relay ALARM 2   : reset
Relay ACTION 1  : reset
Relay ACTION 2  : reset
Relay FAULT 1   : set
Relay FAULT 2   : set
    
```

Progres	Day-Month	Hour:Minute:Second	Event	Temperature 1	Temperature 2	Flow 1	Flow 2	Smoke Level 1	Smoke Level 2	RPM blower
1	24-10	10:30:00	1	24	24	97	95	50	50	3300
2	25-10	10:48:13	302	24	24	97	95	200	50	3300
3	25-10	10:53:24	1302	24	24	97	95	50	50	3300
4	26-10	11:00:02	2	24	24	97	95	50	50	3300
5	26-10	11:01:06	24	24	24	97	95	50	50	3300
6	26-10	11:11:10	25	24	24	97	95	50	50	3300

Figure 21-2: Sample Event Log

LOG Desc

- Row 1) device power ON
- Row 2) Alarm CH1 smoke level passed from 50 to 200,
- Row 3) Exit from alarm CH1
- Row 4) Front cover opened by operator
- Row 5) Log requested -pushed button enter-
- Row 6) Log downloaded on USB stick.

Sensing Head

Figure 21-3: Smoke Levels Description

Alarm Level	Description	Obscuration Detected		Notes
		Imperial Units	Metric Units	
1	EEPROM error			
5	light compensation fail			
6	photo offset low or high			
7	light start minus dark start > max			
8	negative photo sample			
9	photo sample interrupted or ADC time/out			
40 ... 50	Normal			Drift Level: 50 =clean, 40 =100% drift
110	Alarm level 0	70% of level 1	70% of level 1	Action if Alarm level configured as HIGH in Out of box Mode
120	Alarm level 1	0.02 % obs/ft	0.07 % obs/m	Alarm if Alarm level configured as HIGH in Out of box Mode
130	Alarm level 2	0.03 % obs/ft	0.10 % obs/m	Action if Alarm level configured as MEDIUM in Out of box Mode
140	Alarm level 3	0.05 % obs/ft	0.16 % obs/m	Alarm if Alarm level configured as MEDIUM in Out of box Mode
150	Alarm level 4	0.10 % obs/ft	0.33 % obs/m	Action if Alarm level configured as LOW in Out of box Mode
160	Alarm level 5	0.20 % obs/ft	0.66 % obs/m	Alarm if Alarm level configured as LOW in Out of box Mode
170	Alarm level 6	0.50 % obs/ft	1.64 % obs/m	Not approved under EN54-20 regulatory
180	Alarm level 7	1.00 % obs/ft	3.28 % obs/m	Not approved under EN54-20 regulatory
190	Alarm level 8	1.50 % obs/ft	4.92 % obs/m	Not approved under EN54-20 regulatory
200	Alarm level 9	2.00 % obs/ft	6.56 % obs/m	Not approved under EN54-20 regulatory

22 Piping Design Guidelines

Proper operation of the FAAST FLEX is highly dependent on proper design and installation of the inlet piping. For the detector to perform at maximum efficiency the inlet piping must collect ambient air from the protected space and deliver it to the detector with unobstructed airflow. The factors that impact this process include the following:

- Length and diameter of inlet piping
- Angle and location of bends in inlet piping
- Length of exhaust piping
- Location, diameter and spacing of air collection holes
- Aspirator speed
- Alarm Levels
- Presence/absence of filter

The following figures illustrate the various parameters used in the calculations provided in the Piping Tables on the following pages:

Single Channel:

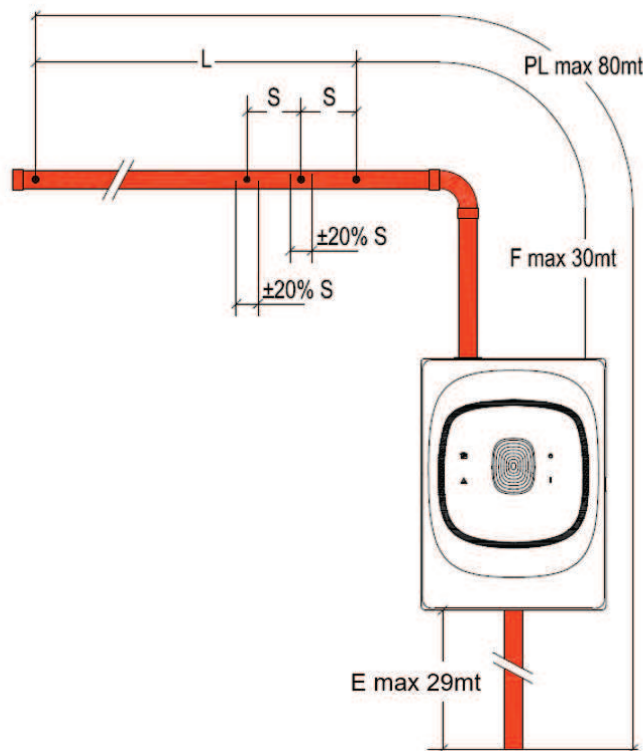

Rules		
Pipe Length with low aspirator speed with high aspirator speed	PL	max 50m max 80m
Exhaust	E	max 29m
First hole position	F	30m - E min 1m
Last hole position	L	PL - E - F
Step between holes	S	L / (Number of holes-1) min 2.5m
Hole position deviation from nominal position		S ± 20%
45° or 90° Bend corresponds to a straight pipe length of		0.3m
T junction corresponds to a straight pipe length of		1.2m
Clips distance		max 1.5m
TT		max 90s

Figure 22-1: Piping Design Parameters - I Pipe

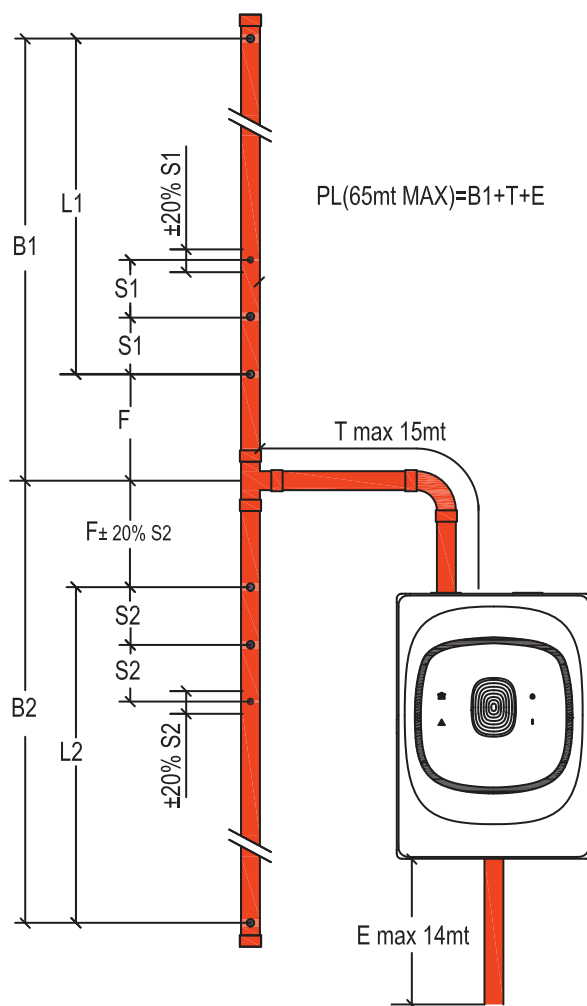

Rules		
Pipe Length with low aspirator speed with high aspirator speed	PL (E+T+B1)	max 45m max 65m
Exhaust	E	max 14m
T-junction position	T	max 15m - E
Branch 1 Length	B1	PL-T-E
Branch 2 Length	B2	B1-10% ÷ B1
First hole position, Branch 1	F	max 30m - E min 1.25m
First hole position, Branch 2	F2	F ± 20% * S2 min 1.25m
Last hole position	L1, L2	PL - E - F - Fx
Step between holes	S1, S2	Lx / (Number of branch holes-1) min 2.5m
Hole position deviation from nominal position		Sx ± 20%
45° or 90° Bend corresponds to a straight pipe length of		0.3m
T junction corresponds to a straight pipe length of 1.2m on the common branch		
Clips distance		max 1.5m
TT		max 90s

Figure 22-2: Piping Design Parameters - U Pipe

Dual Channel:

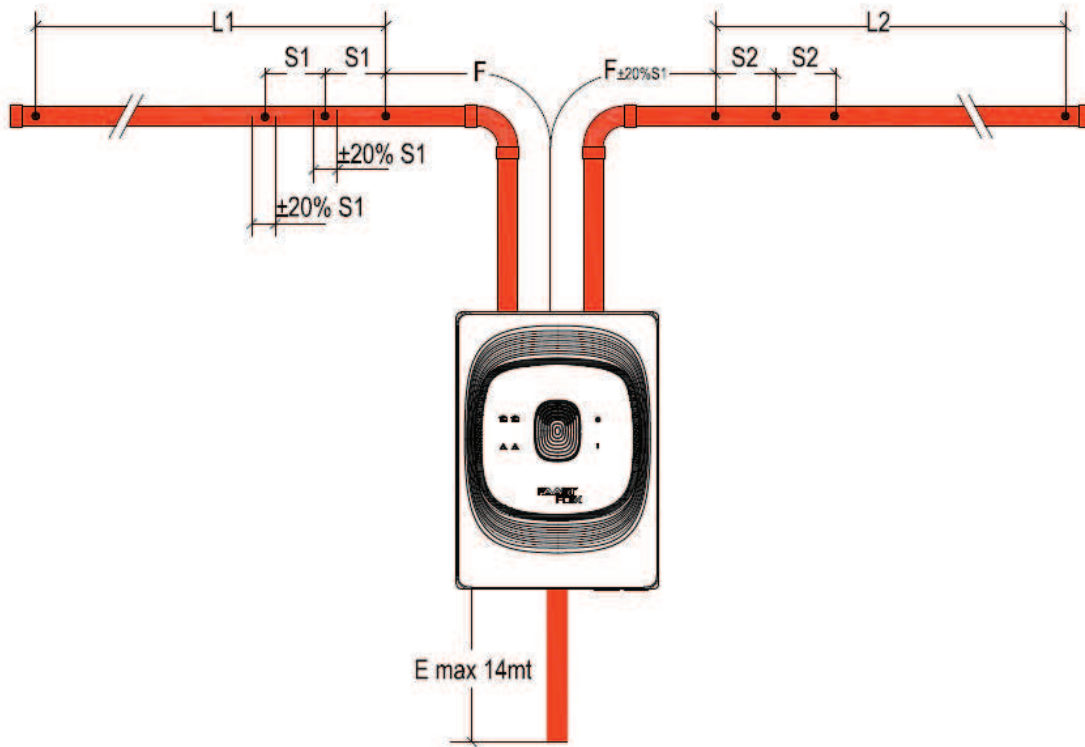

Rules		
Pipe Length with low aspirator speed with high aspirator speed	PL	max 50m max 80m
Exhaust	E	see table row B
First hole position, Chamber 1	F	max (see table row A) -E min 1m
Last hole position, Chamber 1	L1	PL - T - F
Last hole position, Chamber 2	L2	L1-10%÷L1
First hole position, Chamber 2	F2	F ± 20%*S2
Step between holes	S1, S2	Lx / (Number of branch holes-1)
Hole position deviation from nominal position		Sx ± 20%
45° or 90° Bend corresponds to a straight pipe length of		0.3m
T junction corresponds to a straight pipe length of 1.2m on the common branch		
Clips distance		max 1.5m
TT		max 90s

Figure 22-3: Piping Design Parameters - I Pipe

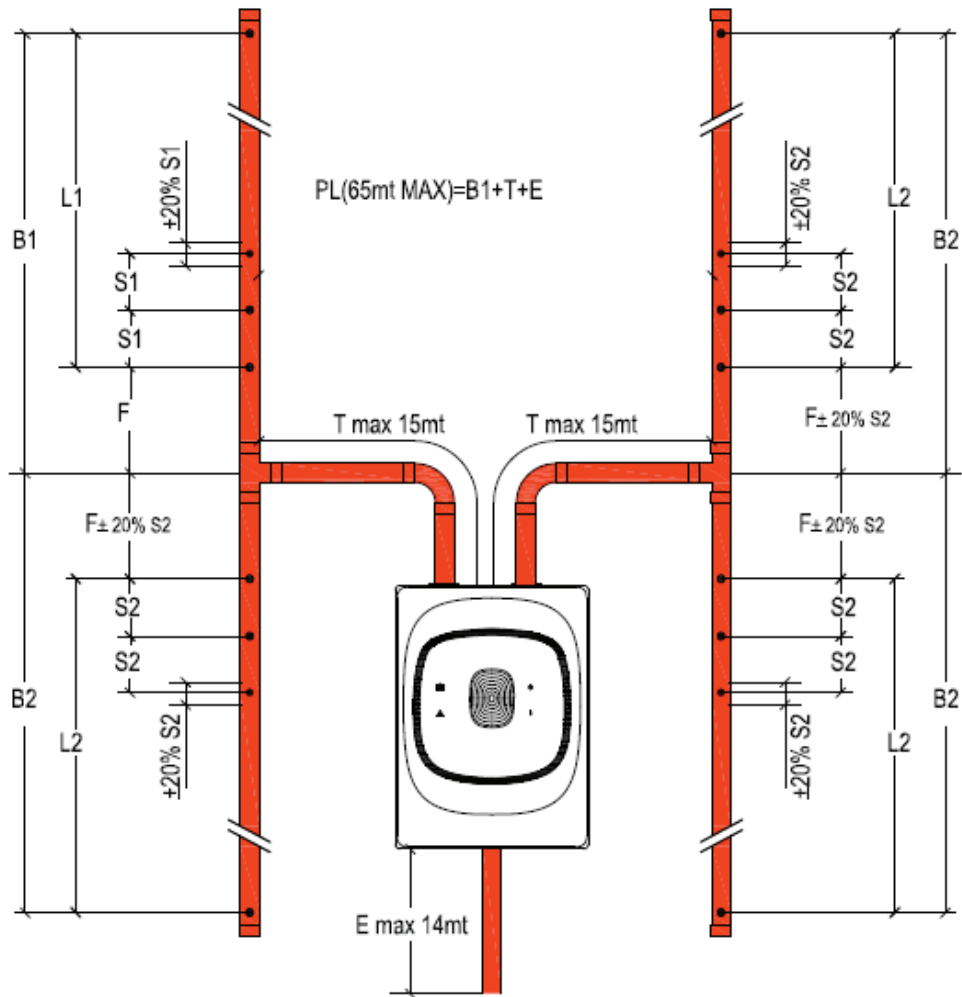

Rules		
Pipe Length with low aspirator speed with high aspirator speed	PL (E+T+B1)	max 45m max 65m
Exhaust	E	see table row C
T-junction position	T	max (see table row A) -E
Branch 1 Length	B1	PL-T-E
Branch 2 Length	B2	B1-10%÷B1
First hole position, Branch 1	F	max (see Table row B) - E - T min 1.25m
First hole position, Branch 2	F2	$F \pm 20\% * S2$ min 1.25m
Last hole position	L1, L2	PL - E - F - Fx
Step between holes	S1, S2	$Lx / (\text{Number of branch holes}-1)$ min 2.5m
Hole position deviation from nominal position		$Sx \pm 20\%$
45° or 90° Bend corresponds to a straight pipe length of		0.3m
T junction corresponds to a straight pipe length of 1.2m on the common branch		
Clips distance		max 1.5m
TT		max 90s

Figure 22-4: Piping Design Parameters - U Pipe

Piping Design "I" pipe - Single Channel (FLX-010):

Example:

I-pipe network, Class C with In-line filter

Exhaust pipe of 10m (E), First hole at 20m (F), Last hole at 40m from the first hole (L), 9 holes

1. Verification of project constraints and determination of aspirator speed

		Required	Rules
E	Exhaust pipe	10m	≤ 29 m ✓
F	First hole	20m	1 ÷ 30m-E ✓
L	Last hole	40m	
PL	Pipe length with low speed with high aspirator speed	10+20+40=70m	≤ 50 m ✗ ≤ 80 m ✓
N	Number of holes	9	See Table ✓

1

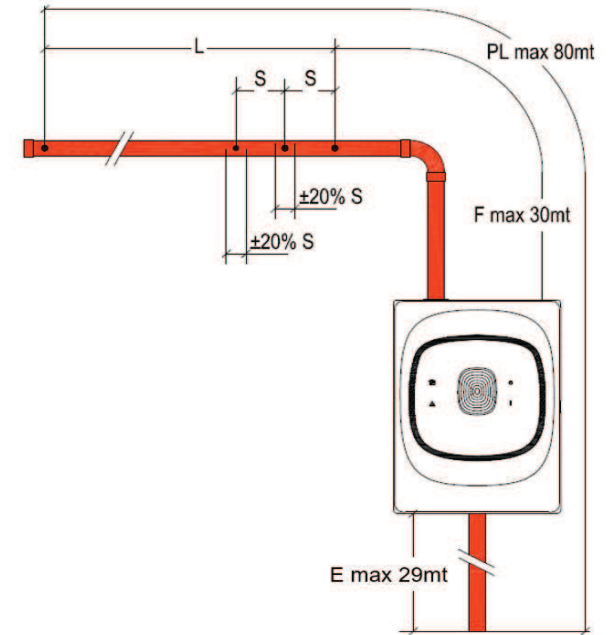

2. Calculate nominal step between holes and hole position deviation form nominal

$$S = L / (\text{Number of holes} - 1) = 40 / 8 = 5 \text{ m } (\geq 2.5\text{m}) \checkmark$$

$$\pm 0.2 * 5\text{m} = \pm 1\text{m}$$

3. Determination of necessary Sensitivity Level and the hole diameters

2

3

Number of Holes	2	3	4	5	6	7	8	9
Aspirator speed, max 80m for H and 50m for I	H/L	H/L	H/L	H/L	H/L	H/L	H/L	H/L
Alarm Level Class C with/without filter	Low	Low	Low	Low	Medium	Medium	Medium	Medium
Alarm Level Class B with/without filter	High	High	High	High	High	High	High	High
Alarm Level Class A without filter only	High	High	High	-	-	-	-	-

1

2

3

Number of Holes	2	3	4	5	6	7	8	9	10	11	12	13	14	15	16	17	18	19	20	21	22
Aspirator speed, max 80m for H and 50m for L	H/L	H/L	H/L	H/L	H/L	H/L	H/L	H/L	H/L	H/L	H/L	H/L	H/L	H/L	H	H	H	H	H	H	H
Alarm Level Class C with/without filter	Low	Low	Low	Low	Medium	Medium	Medium	Medium	Medium	High	High	High	High	High	High	High	High	High	High	High	High
Alarm Level Class B with/without filter	High	High	High	High	High	High	High	High	High	High	High	High	-	-	-	-	-	-	-	-	-
Alarm Level Class A without filter only	High	High	High	-	-	-	-	-	-	-	-	-	-	-	-	-	-	-	-	-	-
Drilled hole diameter (mm)	H1 6.5	H1 5.5	H1 4.5	H1 4	H1 3.5	H1 3.5	H1 3	H1 3	H1 2.5	H1 2.5	H1 2.5	H1 2.5	H1 2.5	H1 2	H1 2	H1 2	H1 2	H1 2	H1 2	H1 2	H1 2
	H2 6.5	H2 5.5	H2 4.5	H2 4	H2 3.5	H2 3.5	H2 3	H2 3	H2 2.5	H2 2.5	H2 2.5	H2 2.5	H2 2.5	H2 2	H2 2	H2 2	H2 2	H2 2	H2 2	H2 2	H2 2
		H3 5.5	H3 4.5	H3 4	H3 3.5	H3 3.5	H3 3.5	H3 3	H3 2.5	H3 2.5	H3 2.5	H3 2.5	H3 2.5	H3 2	H3 2	H3 2	H3 2	H3 2	H3 2	H3 2	H3 2
			H4 4.5	H4 4	H4 3.5	H4 3.5	H4 3.5	H4 3.5	H4 2.5	H4 2.5	H4 2.5	H4 3	H4 2.5	H4 2.5	H4 2	H4 2	H4 2	H4 2	H4 2	H4 2	H4 2
				H5 4.5	H5 3.5	H5 3.5	H5 3.5	H5 3.5	H5 3	H5 2.5	H5 2.5	H5 3	H5 2.5	H5 2.5	H5 2.5	H5 2	H5 2	H5 2	H5 2	H5 2	H5 2
					H6 4	H6 3.5	H6 3.5	H6 3.5	H6 3	H6 3	H6 2.5	H6 3	H6 2.5	H6 2.5	H6 2.5	H6 2.5	H6 2.5	H6 2.5	H6 2	H6 2	H6 2
						H7 4	H7 3.5	H7 3.5	H7 3	H7 3	H7 2.5	H7 3	H7 3	H7 2.5	H7 2.5	H7 2.5	H7 2.5	H7 2.5	H7 2.5	H7 2.5	H7 2.5
							H8 4	H8 3.5	H8 3	H8 3	H8 3	H8 3	H8 3	H8 3	H8 2.5	H8 2.5	H8 2.5	H8 2.5	H8 2.5	H8 2.5	H8 2.5
								H9 4	H9 3	H9 3	H9 3	H9 3	H9 3	H9 2.5	H9 2.5	H9 2.5	H9 2.5	H9 2.5	H9 2.5	H9 2.5	H9 2.5
									H10 3.5	H10 3	H10 3	H10 3.5	H10 3	H10 2.5	H10 2.5	H10 2.5	H10 2.5	H10 2.5	H10 2.5	H10 2.5	H10 2.5
										H11 3.5	H11 3	H11 3.5	H11 3	H11 2.5	H11 2.5	H11 2.5	H11 2.5	H11 2.5	H11 2.5	H11 2.5	H11 2.5
											H12 3.5	H12 3.5	H12 3	H12 3	H12 2.5	H12 2.5	H12 2.5	H12 2.5	H12 2.5	H12 2.5	H12 2.5
												H13 4	H13 3	H13 3	H13 2.5	H13 2.5	H13 2.5	H13 3	H13 3	H13 2.5	H13 2.5
													H14 4	H14 3	H14 2.5	H14 2.5	H14 2.5	H14 3	H14 3	H14 2.5	H14 3
														H15 3.5	H15 2.5	H15 2.5	H15 3	H15 3	H15 3	H15 2.5	H15 3
															H16 3.5	H16 3	H16 3	H16 3	H16 3	H16 3	H16 3
																H17 3.5	H17 3	H17 3	H17 3	H17 3	H17 3
																	H18 3.5	H18 3	H18 3	H18 3	H18 3
																		H19 4	H19 3	H19 3	H19 3.5
																			H20 4	H20 3	H20 3.5
																				H21 4	H21 3.5
																					H22 4.5

Piping Design "U" Pipe - Single Channel (FLX-010):

Example:

U-pipe network, Class C with In-line filter

Exhaust pipe of 5m (E), T-junction 10m (T), Branch of 30m (B1), First hole at 5m (F), 6 holes ...

1. Verification of project constraints and determination of aspirator speed

		Required	Rules
E	Exhaust pipe	5m	≤ 14 m ✓
T	T-junction position	10	≤ 10 m (15m-E) ✓
B1	Branch length	30m	
F	First hole, Branch 1	5m	1.25 ÷ 25m ✓
PL	Pipe length with low speed with high aspirator speed	5+10+30=45m	≤ 45 m ✓ ≤ 65 m ✓
L1	Last hole position, Branch 1	45-5-10-5=25m	
N	Number of holes	6	See Table ✓ 1

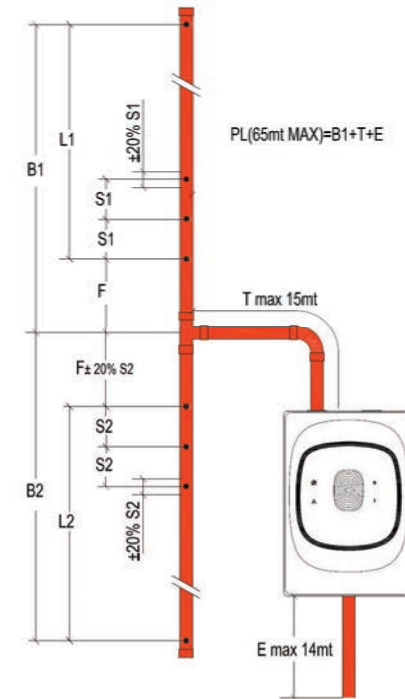

2. Calculate nominal step between holes and hole position deviation form nominal

$$S1 = L1 / (\text{Number of holes} - 1) = 25 / 5 = 5 \text{ m } (\geq 2.5\text{m}) \checkmark$$

$$\pm 0.2 * 5\text{m} = \pm 1\text{m}$$

3. Determination of necessary Sensitivity Level and the hole diameters **2**

Branch Number of Holes	1	2	3	4	5	6
Aspirator speed, max 65m for H and 45m for L	H/L	H/L	H/L	H/L	H/L	H/
Alarm Level Class C with/without filter	Low	Low	Medium	Medium	Medium	High
Alarm Level Class B with/without filter	High	High	High	High	High	High
Alarm Level Class A without filter only	High	High	-	-	-	-
Drilled hole diameter (mm)	H1 6.5	H1 5.5	H1 4.5	H1 3.5	H1 3.5	H1 3.5

Example:

U-pipe network, Class C with In-line filter
 Exhaust pipe of 5m (E), T-junction 10m (T), Branch of 30m (B1), First hole at 5m (F), 6 holes and Branch 2 of 28m (B2)

		Required	Rules
E	Exhaust pipe	5m	≤ 14 m ✓
T	T-junction position	10	≤ 10 m (15m-E) ✓
B1	Branch length	30m	
F	First hole, Branch 1	5m	1.25 ÷ 25m ✓
PL	Pipe length with low speed with high aspirator speed	5+10+30=45m	≤ 45 m ✓ ≤ 65 m ✓
L1	Last hole position, Branch 1	45-5-10-5=25m	
N	Number of holes	6	See Table ✓
B2	Branch 2 length	28m	27 ÷ 30m ✓
L2	Last hole, Branch 2	28-5=23m	

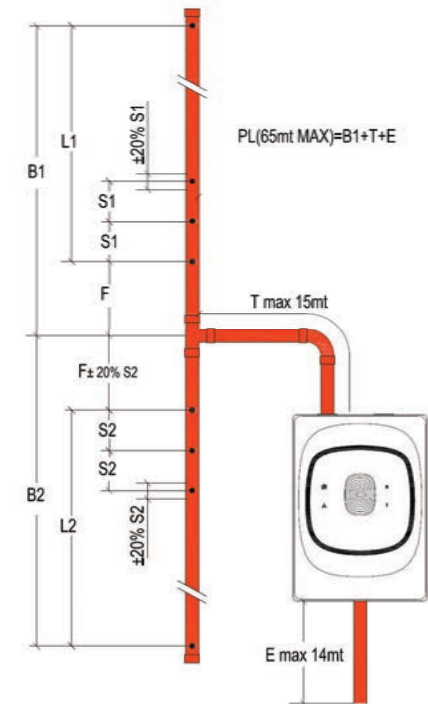

4. For Branch 2, calculate nominal step between holes and hole position deviation from nominal

$$S2 = L2 / (\text{Number of holes} - 1) = 23 / 5 = 4.6 \text{ m } (\geq 2,5\text{m}) \quad \checkmark$$

$$\pm 0.2 * 4.6\text{m} = \pm 0.9\text{m}$$

5. For Branch 2, first hole position can be **5±0.9m**

Branch Number of Holes	1	2	3	4	5	6	7	8	9	10	11
Aspirator speed, max 65m for H and 45m for L	H/L	H/L	H/L	H/L	H/L	H/L	H/L	H/L	H/L	H/L	H
Alarm Level Class C with/without filter	Low	Low	Medium	Medium	Medium	High	High	High	High	High	High
Alarm Level Class B with/without filter	High	High	High	High	High	High	High	-	-	-	-
Alarm Level Class A without filter only	High	High	-	-	-	-	-	-	-	-	-
Drilled hole diameter (mm)	H1 6.5	H1 5.5	H1 4.5	H1 3.5	H1 3.5	H1 3	H1 3	H1 3	H1 2.5	H1 2	H1 2
		H2 5.5	H2 4.5	H2 4	H2 3.5	H2 3.5	H2 3	H2 3	H2 2.5	H2 2	H2 2
			H3 5	H3 4	H3 3.5	H3 3.5	H3 3.5	H3 3	H3 2.5	H3 2	H3 2
				H4 4.5	H4 4	H4 4	H4 3.5	H4 3	H4 3	H4 2	H4 2
					H5 4.5	H5 4	H5 4	H5 3.5	H5 3	H5 2.5	H5 2
						H6 4.5	H6 4	H6 3.5	H6 3	H6 2.5	H6 2
							H7 4.5	H7 4	H7 3	H7 2.5	H7 2
								H8 4.5	H8 3.5	H8 2.5	H8 2
									H9 4	H9 3	H9 2.5
										H10 3.5	H10 2.5
											H11 3

Piping Design "I" pipe - Dual Channel (FLX-020):

Example:

FLX-020 I-pipe network, Class C without In-line filter
 Exhaust pipe of 10m (E), First hole at 5m (F), Last hole at 35m from the first hole (L1), 6 holes
 ...

1. Verification of project constraints and determination of aspirator speed

		Required	Rules
N	Number of holes	6	See Table ✓ 1
E	Exhaust pipe	10m	max 14 (See Table row B) ✓
F	First hole with low speed with high aspirator speed	5m	1 ÷ (26-10) ✓ 1 ÷ (30-10) 2
L1	Last hole	35m	
PL	Pipe length with low speed with high aspirator speed	10+5+35=50m	≤ 50 m ✓ ≤ 80 m ✓

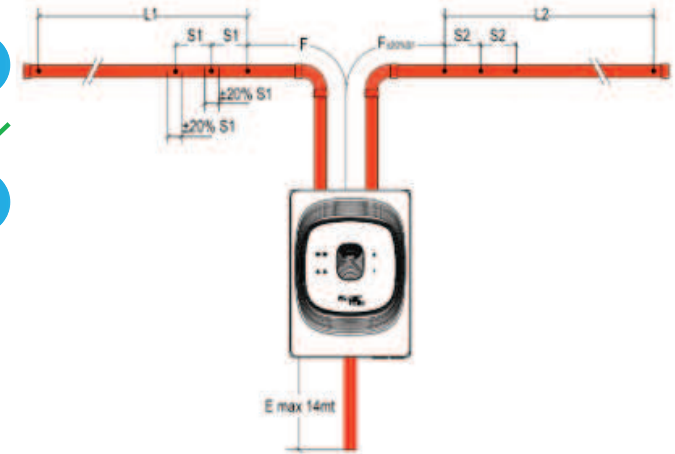

2. Calculate nominal step between holes and hole position deviation form nominal

$$S1 = L1 / (\text{Number of holes} - 1) = 35 / 5 = 7 \text{ m } (\geq 2.5\text{m}) \checkmark$$

$$\pm 0.2 * 7\text{m} = \pm 1.4\text{m}$$

3. Determination of necessary Sensitivity Level **3** and the hole diameters **4**

Branch Number of Holes	1	2	3	4	5	6
Aspirator speed, max 65m for H and 45m for L	H/L	H/L	H/L	H/L	H/L	H/L
A - Maximum First Hole Distance (meters)	NN	30/30	30/30	30/30	30/30	30/26
B - Maximum Exhaust Pipe Length (meters)	14/14	14/14	14/14	14/14	14/14	14/14
Alarm Level Class C with/without filter	Low	Low	Low	Medium	Medium	Medium
Alarm Level Class B with/without filter	High	High	High	High	High	High
Alarm Level Class A without filter only	High	High	High	-	-	-
Drilled hole diameter (mm)	H1 6.5	H1 6	H1 5	H1 4	H1 4	H1 4

Example:

FLX-020 I-pipe network, Class C without In-line filter
 Exhaust pipe of 10m (E), First hole at 5m (F), Last hole at 35m from the first hole (L1), 6 holes chamber 2: first hole at 4m (F2), Last hole at 33m from the first hole (L2)

		Required	Rules
N	Number of holes	6	See Table ✓
E	Exhaust pipe	10m	max 14 (See Table row B) ✓
F	First hole with low speed with high aspirator speed	5m	1 ÷ (26-10) ✓ 1 ÷ (30-10)
L1	Last hole	35m	
PL	Pipe length with low speed with high aspirator speed	10+5+35=50m	≤ 50 m ✓ ≤ 80 m ✓
L1	Last hole, chamber 2	33m	

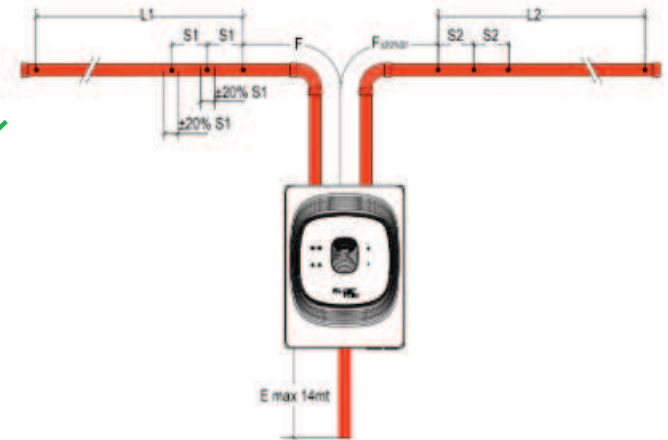

4. Verify that branch 2 first hole position (4m) satisfies rules

$$F2_{min} = F - 0.2 \cdot S1 = 5m - 0.2 \cdot 7 = \mathbf{3.6\ m} \quad \checkmark$$

5. Calculate nominal step between holes and hole position deviation from nominal for branch 2

$$S2 = L2 / (\text{Number of holes} - 1) = 33 / 5 = \mathbf{6.6\ m} \quad (\geq 2.5m)$$

$$\pm 0.2 \cdot 6.6m = \mathbf{\pm 1.3m}$$

Branch Number of Holes	1	2	3	4	5	6	7	8	9	10	11	12	13	14	15	16	17	18
Aspirator speed, max 65m for H and 45m for L	H/L	H/L	H/L	H/L	H/L	H/L	H/L	H/L	H/L	H/L	H/L	H	H	H	H	H	H	H
A - Maximum First Hole Distance (meters)	NN	30/30	30/30	30/30	30/30	30/26	30/22	30/17	30/13	30/8	30/3	28	24	19	15	10	6	1
B - Maximum Exhaust Pipe Length (meters)	14/14	14/14	14/14	14/14	14/14	14/14	14/14	14/14	14/12	14/7	14/2	14	14	14	14	9	5	0
Alarm Level Class C with/without filter	Low	Low	Low	Medium	Medium	Medium	Medium	Medium	High	High	High	High	High	High	High	High	High	High
Alarm Level Class B with/without filter	High	High	High	High	High	High	High	High	-	-	-	-	-	-	-	-	-	-
Alarm Level Class A without filter only	High	High	High	-	-	-	-	-	-	-	-	-	-	-	-	-	-	-
Drilled hole diameter (mm)	H1 6.5	H1 6	H1 5	H1 4	H1 4	H1 3	H1 3	H1 3	H1 2.5	H1 2.5	H1 2.5	H1 2.5	H1 2	H1 2	H1 2	H1 2	H1 2	H1 2
		H2 6	H2 5	H2 4	H2 4	H2 4	H2 3.5	H2 3	H2 2.5	H2 2.5	H2 2.5	H2 2.5	H2 2	H2 2	H2 2	H2 2	H2 2	H2 2
			H3 6	H3 5	H3 4	H3 4	H3 3.5	H3 3	H3 3	H3 3	H3 2.5	H3 2.5	H3 2	H3 2	H3 2	H3 2	H3 2	H3 2
				H4 6	H4 5	H4 4	H4 4	H4 3.5	H4 3	H4 3	H4 2.5	H4 2.5	H4 2	H4 2.5	H4 2	H4 2	H4 2	H4 2
					H5 6	H5 5	H5 4	H5 4	H5 3.5	H5 3	H5 3	H5 2.5	H5 2.5	H5 2.5	H5 2.5	H5 2	H5 2	H5 2
						H6 6	H6 4.5	H6 4	H6 4	H6 3.5	H6 3	H6 3	H6 3	H6 2.5	H6 2.5	H6 2.5	H6 2	H6 2
								H7 6	H7 5	H7 4.5	H7 4	H7 3.5	H7 3	H7 3	H7 2.5	H7 2.5	H7 2	H7 2
									H8 6	H8 5	H8 4	H8 4	H8 3.5	H8 3.5	H8 2.5	H8 2.5	H8 2	H8 2
										H9 6	H9 4.5	H9 4	H9 3.5	H9 3.5	H9 3	H9 2.5	H9 2	H9 2
											H10 6	H10 4.5	H10 4	H10 4	H10 3	H10 3	H10 2.5	H10 2
												H11 6	H11 4	H11 4	H11 3	H11 3	H11 2.5	H11 2.5
													H12 6	H12 5	H12 3	H12 3	H12 2.5	H12 2.5
															H13 6	H13 3.5	H13 3	H13 2.5
																H14 5	H14 3.5	H14 3
																	H15 5	H15 3
																		H16 5
																		H17 5
																		H18 5

Piping Design "U" pipe - Dual Channel (FLX-020):

Example:

FLX-020 U-pipe network, Class C with In-line filter
 Without Exhaust pipe (E), T-junction 1m (T), Branch of 40m (B1), First hole at 20m (F), 6 holes

1. Verification of project constraints and determination of aspirator speed

		Required	Rules
N	Number of holes	6	See Table ✓
E	Exhaust pipe	0m	See Table row C ✓
T	T-junction position	1m	See Table row A ✓
B1	Branch length	10m	
F	First hole Branch 1 with low speed with high aspirator speed	20m	1.25 ÷ 18m (19-1) ✗ 1.25 ÷ 29m (30-1) ✓
PL	Pipe length with high aspirator speed	40+1+0=41m	≤ 65 m ✓
L1	Last hole position, Branch 1	41-1-20=20m	

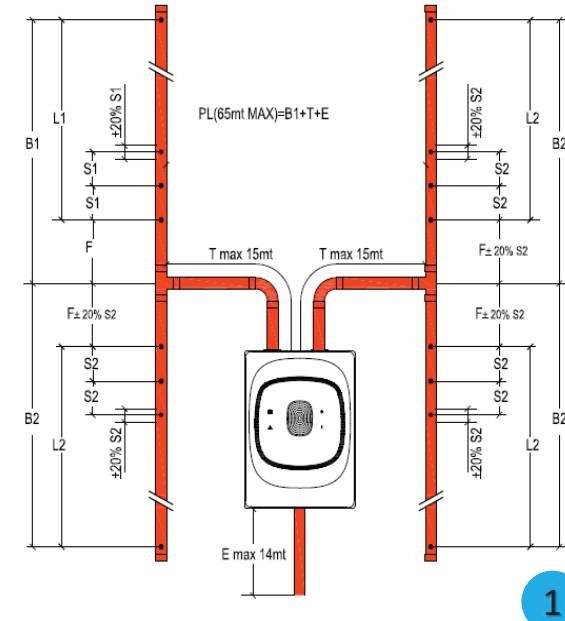

2. Calculate nominal step between holes and hole position deviation form nominal

$S1 = L1 / (\text{Number of holes} - 1) = 20 / 5 = 4 \text{ m } (\geq 2.5\text{m}) \checkmark$

$\pm 0.2 * 4\text{m} = \pm 0.8\text{m}$

3. Determination of necessary Sensitivity Level and the hole diameters

Branch Number of Holes	1	2	3	4	5	6
Aspirator speed, max 65m for H and 45m for L	H/L	H/L	H/L	H/L	H/L	H/L
A - Maximum T-Junction Distance (meters)	15/15	15/15	15/15	15/15	15/15	15/15
B - Maximum First Hole Distance (meters)	30/30	30/30	30/30	30/27	30/23	30/19
C - Maximum Exhaust Pipe Length (meters)	14/14	14/14	14/14	14/14	14/14	14/14
Alarm Level Class C with/without filter	Low	Low	Medium	High	High	High
Alarm Level Class B with/without filter	High	High			-	-
Alarm Level Class A without filter only	High	-			-	-

Branch Number of Holes	1	2	3	4	5	6	7	8	9
Aspirator speed, max 65m for H and 45m for L	H/L	H/L	H/L	H/L	H/L	H/L	H/L	H	H
A - Maximum T-Junction Distance (meters)	15/15	15/15	15/15	15/15	15/15	15/15	15/13	15	6
B - Maximum First Hole Distance (meters)	30/30	30/30	30/30	30/27	30/23	30/19	30/15	15.25	7.25
C - Maximum Exhaust Pipe Length (meters)	14/14	14/14	14/14	14/14	14/14	14/14	14/13	14	6
Alarm Level Class C with/without filter	Low	Low	Medium	High	High	High	High	High	High
Alarm Level Class B with/without filter	High	High	High	High	-	-	-	-	-
Alarm Level Class A without filter only	High	-	-	-	-	-	-	-	-
Drilled hole diameter (mm)	H1 6	H1 4	H1 3	H1 3	H1 2.5	H1 2.5	H1 2	H1 2	H1 2
		H2 6	H2 4	H2 3	H2 3	H2 2.5	H2 2.5	H2 2	H2 2
			H3 6	H3 3	H3 3	H3 2.5	H3 2.5	H3 2.5	H3 2
				H4 6	H4 3	H4 3	H4 2.5	H4 2.5	H4 2
					H5 6	H5 3	H5 2.5	H5 2.5	H5 2.5
						H6 6	H6 3	H6 2.5	H6 2.5
							H7 6	H7 3	H7 2.5
								H8 6	H8 2.5
									H9 5.5

23 Battery Removal for Recycling

1. Remove the manifold by detaching the two clips.
2. Rotate the manifold and the sensing head to access the detector circuit.

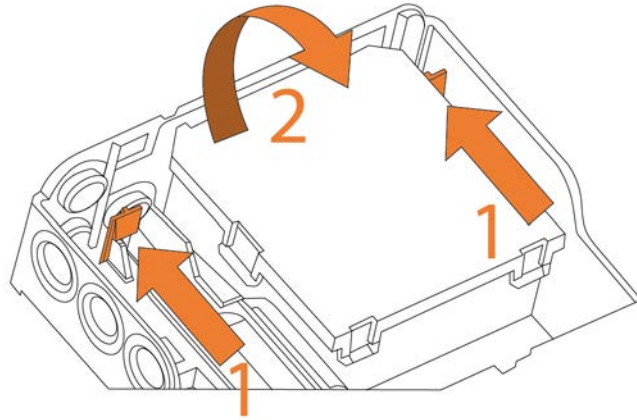

3. Remove the PCB from the plastic base.

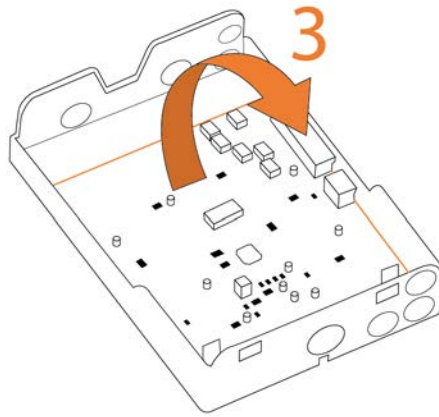

4. Remove the battery using a small screwdriver and following the directions of the arrow.

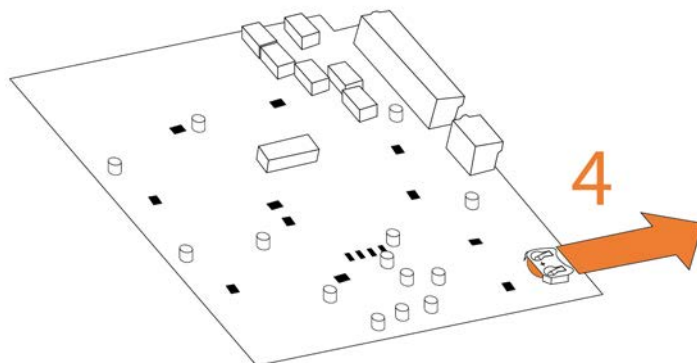

5. Recycle the CR2032 Lithium battery in accordance with your local regulations.

